

ZEISS HISTORICA

Journal of the Zeiss Historica Society • Volume 35 • Number 1 • Spring 2013



Table of Contents

1	President's Letter	
2	The Planar <i>A design older than the Tessar that has proved its long-term value</i>	H.H. Nasse
6	Werra—the design miracle from Eastern Germany <i>The camera combines elegant design, ease of use, and many novel features</i>	Manfred Herrmann
13	The Aseros <i>A zoom telescope from the 1920s</i>	Larry Gubas
15	Carl Zeiss Kamera Register 1902–2012 <i>A review of this important new book, and an interview with its author</i>	Manfred Herrmann
18	The Contarex Book — a review <i>Two authors combine to make a compilation of all the bodies and lenses</i>	Larry Gubas
20	Three early Zeiss apochromats <i>In 1890 their durability was doubted, and we now know that was true</i>	Fritz Schulze
22	The Optovar <i>A microscope accessory that provides quick and easy magnification changes</i>	Fritz Schulze
24	The Canadian \$100 banknote <i>The microscope illustrated does not look quite like the Zeiss Axioplan</i>	Fritz Schulze

The Zeiss Historica Society of America is an educational, non-profit organization dedicated to the exchange of information on the history of the Carl Zeiss optical company and its affiliates, people and products from 1846 to the present.

Officers

Co-Founders	Thomas Schreiner Charles Barringer, Jr.
President	Lawrence J. Gubas
Secretary	Warren R. Winter
Editor, Treasurer	John T. Scott

Material for the journal can be sent to the Editor at 4507 Mountain Path Drive, Austin TX 78759 USA, or to editor@zeisshistorica.org. Annual membership dues: \$40 (USA), \$50 elsewhere. Credit-card payment option (Mastercard, Visa) is available. Dues include subscription to *Zeiss Historica*, airmail postage overseas. Send general enquiries to the secretary at PO Box 556, Mount Kisco, NY 10549, USA

Website: www.zeisshistorica.org

© Zeiss Historica Society, 2013. ISSN: 1553-5371. Reproduction without permission is prohibited. Trademarks and names that are the property of Carl Zeiss are used with permission.

Printing by Minuteman Press, 3007 Longhorn Blvd, Suite 110, Austin, Texas 78758 USA.

Front cover: Bernd K. Otto (on the left) discusses his new book, "Carl Zeiss Kamera Register 1902–2012," with the reviewer, Manfred Herrmann, on the right. (Photo by Brunhild Goubeaud-Herrmann)



Back cover: The green Werra IV with its two interchangeable lenses — the f/2.8 35 mm Flektogon and the f/4 100 mm Cardinar. Note the bulbous shape of the lens hood, as compared with earlier Werras. (Photo by Stefan Köser)



President's letter

Greetings!

I am happy to report a good six-month period of relatively good health for a change. I have made good progress and look forward for an active summer of new photos with my "new" Sony camera with an impressive Vario-Sonnar lens with an incredible 30× zoom range, megapixels galore and the ability to make wonderful panoramic pictures.

This issue brings a lot of information about books of all sorts. First of all, the long awaited "Carl Zeiss Kamera Register 1902–2012" by Bernd Otto is finally available. It is a huge volume of 1310 pages with a historical overview as the first chapter in German, English and Japanese that fill the first 56 pages. However, the bulk of the book is devoted to a register that documents every camera made by a firm when under the control of the Carl Zeiss Stiftung. This means that it is an encyclopedia-like documentation of each and every camera, its features and variations. It is not a picture book, except for that first chapter and a small sample image of each camera at the top of a page or pages devoted to that camera. For a historian type such as me, it is a godsend because it takes all the drudgery of detailed archival research out of the process. It is clear, accurate and detailed but not everyone's cup of tea. I advise that you look at the www.camerabooks.com website for particulars and an overview. It is huge and expensive due to its size and complexity when mailing charges are taken into consideration. It lists at \$245 plus shipping. It weighs 13 pounds.

Dr Wimmer of the Carl Zeiss Jena Archives has also published a new history on a subject not related to cameras but rather to the groundbreaking work done by Zeiss in the area of spectacle lenses. You can find it at www.amazon.com under "Better Vision: Carl Zeiss Eyeglass Lenses 1912–2012," by Stephan Paetrow. If it does not appear at Amazon, use your search engine with the title and author. Remember that it is available in both German and English. Choose your language carefully.

This issue is filled with more material on the Werra cameras by Manfred Hermann as well as an interview by Manfred with Bernd Otto about his research. I have contributed a review of "the Contarex book" from Pierpaolo Ghisetti and Marco Cavino and a commentary about a wonderful hand-held zoom telescope from the 1920s, the Aseros. Also, we have an abridged version of an essay by

Zeiss optical designer, Dr Hubert Nasse, about the history of the Planar lens, which preceded the Tessar by five years or so and was reinvigorated by the discovery of lens coatings. This formula is still a quite viable product today, nearly 115 years after its first appearance.

The two cameras using the trademark, Zeiss Ikon, have been discontinued by Zeiss and Cosina after a life span of 8 years or so. That is impressive lifecycle for this day and age. It would seem the digital world is getting still stronger as Zeiss is vigorously working with Sony on a topic that I am totally ignorant about — the mirror-less cameras. I am sure to find out more soon.

My own book is nearly ready to send to the printer. I am still mulling over a title, but it is the word and picture story of the involvement of Carl Zeiss, Zeiss Ikon and their associates in the world of photography from 1890 to today. It has topped out at 888 pages laid out in the publishing program and I will be discussing the next steps with my printer this week. I am doing my best to keep the cost of the book at a reasonable level and I hope that it will be available by August. I will be distributing it through camerabooks.com since I am not able to operate sensibly with the US postal service. I will attempt to create a website for viewing the book before it is over and I am researching the possibility of adding the bibliography and index via a computer disk as part of the book. If I did it via paper, it would raise the cost unreasonably and greatly delay its publishing.

As the Society Archivist, I have received two significant donations from our Past-President (1988), Claus Stegman, of two hard-covered Zeiss Photo Lens catalogs from 1899 and 1901. They are quite large but in German. They are intended as candidates for the reproduction dividend for the membership. I have a similar later example in English and would like to seek guidance as to which you would prefer to receive. Please let me know.

Best wishes to all,

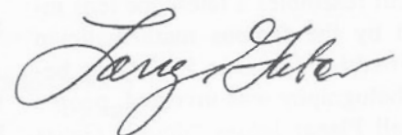

The Planar

H. H. Nasse, Oberkochen, Germany

*Even older than the well-known Tessar,
this lens design has been the basis of the objectives fitted to
high-quality cameras for many years*

Not just a registered trade name for specific Zeiss lenses, the term "Planar" is also used generally for a classic anastigmatic lens design. This is because Planar lenses have been used in the lion's share of high-quality cameras for decades. 50 mm lenses of that type were sold as a standard lens with SLR cameras for a long time, until they were gradually replaced by zoom lenses. The Planar design has been installed in countless variations by many manufacturers, and new designs are constantly entering the market.

The first Planar lens was registered for a patent (figure 1) by its inventor Paul Rudolph at Carl Zeiss in Jena, Germany at the end of 1896 and was added to the Carl Zeiss product range in various focal lengths as early as 1897. In other words, it is even a few years older than the Tessar lens. This lens as developed by Rudolph had a strict symmetrical design, (figure 2) with six lens elements assembled in four groups, featuring a pair of meniscus-shaped cemented elements in front of and behind the aperture. (In optics, "meniscus" refers to a lens on which the centers of curvature of both surfaces are on the same side.)

Due to this lens arrangement, Planar lenses also have another name: As each lens-half resembles a telescope lens invented by the famous mathematician Carl-Friedrich Gauss in 1817, long before photography was invented, people also call Planar lenses "double Gauss

This article is Zeiss Historica's adapted and abbreviated version of the original work published online by Hubert Nasse. The full-length version, which includes more technical information about these lenses and MTF curves for many of them, can be found at: http://blogs.zeiss.com/photo/en/wp-content/uploads/2011/07/en_CLB_40_Nasse_Lens_Names_Planar.pdf

or, more simply, by searching the Web for "Nasse lens names Planar."

lenses" or simply the Gauss lens. Such original four-element lenses entered the market around 1880. Much later, starting in 1933, Carl Zeiss offered a wide-angle lens called the Topogon (figure 3), which closely resembled a pair of Gauss telescope lenses, aside from the fact that its lenses had a stronger curvature. It was a standard in aerial photography for a long time, and there was also an f/4 25 mm version for the Contax 35 mm rangefinder camera.

Paul Rudolph, however, strongly modified the original design by increasing the thickness of the inner meniscuses and constructing them out of two different types of glass. They had the same refractive indices, but different dispersion properties. This allowed him to influence the color correction at will, without changing the monochromatic correction, by selecting the right radius for the cemented surface.

Superior sharpness

A result of Rudolph's modifications was the superior image definition delivered by the Planar lens, with an unusually

wide aperture for that time. In particular, the field curvature was very low. In other words, the image was very "plane" or flat – which is precisely what the name "Planar" was supposed to suggest.

A catalog from 1897 stated the following:

"When working with the Planar, keep in mind that slight overexposures can easily result from the high speed of the lens. The precise design of the Planar lens surpasses the anastigmatic double lenses introduced until now. Above all, it is especially suitable for all kinds of reproductions and yields excellent results."

And because chromatic aberrations tend to be more noticeable with line-art originals, in which the contrast between black and white is high, other models soon incorporated the same design, but featured even better chromatic correction thanks to the use of special types of glass (figure 4).

Despite all of these favorable features, the Planar lens enjoyed only marginal success in the beginning. Although the older double anastigmatic lenses (and the later Protar) were not quite as good, they

KAISERLICHES



PATENTAMT.

PATENTSCHRIFT

— № 92313 —

KLASSE 57: PHOTOGRAPHIE.

AUSGEBEN DEN 5. JULI 1897.

FIRMA CARL ZEISS IN JENA.

Astigmatisch, sphärisch und chromatisch corrigirtes Objectiv.

Patentirt im Deutschen Reiche vom 14. November 1896 ab.

Die nachstehend beschriebene Erfindung bezweckt, ein sehr lichtstarkes Objectiv zur Verfügung zu stellen, welches bei guter anastigmatischer Bildebenung über ein großes Gesichtsfeld besonders hohen Anforderungen an die chromatische und sphärische Correction des Bildes genügt. Diesen Zweck erreicht sie dadurch, daß sie das im sogenannten Gaußschen Fernrohrobjectiv zum Ausdruck kommende Correctionsprincip für diesen neuen Zweck nutzbar macht.

Wie bekannt, hat Gauß gezeigt, daß ein zweigliedriges Objectiv besonders vollkommene Correction der chromatischen und sphärischen Abweichung für größere Oeffnung gestattet, wenn man dasselbe gemäß dem in Fig. 1 dargestellten Schema zusammensetzt, nämlich aus einem convexen Crownglasmeniscus *A* und einer convexconcaven Flintglaslinse *B*, deren beide einander zugewendete, durch Luft getrennte Glasflächen erheblich verschiedenes Krümmungsmaß zeigen, sich also nicht mit einander verkitten lassen. Im Gegensatz zu den Objectivtypen von Fraunhofer, Littrow u. A., bei welchen die einander zugekehrten (inneren) Flächen des Systems annähernd gleich starke Krümmungen besitzen, daher auch meist verkittet sind, gestattet der Gauß'sche Typus bei richtiger Vertheilung der Krümmungen gleichzeitige Correction der sphärischen Abweichung für zwei verschiedene Farben, also Aufhebung der sogenannten chromatischen Differenz der sphärischen Abweichung, sowie die Correction

dieser beiden Abweichungen über eine große Oeffnung des Systems. Objective dieser Art sind für astronomische Fernrohre wiederholt mit Erfolg zur Anwendung gekommen, und zwar mit beiden möglichen Anordnungen der Linsen, also sowohl mit »Crown-voraus« als auch mit »Flint voraus«. Eine vortheilhafte Anwendung dieses Zusammensetzungstypus auf photographische Objective hat aber bisher noch nicht stattgefunden, und sie gelingt erst durch die gegenwärtige Erfindung. Entsprechend dem Gauß's - Objectiv sind photographische Systeme wünschenswerth, die ihm noch nicht in dieser Weise Anwendung gegeben ist. Diese Systeme sind eine neue anastigmatische Objectivform für photographische Zwecke, die in der vorliegenden Erfindung zum Ausdruck kommt. Durch die Anwendung dieses Objectivtypus wird es ermöglicht, die in der Photographie bisher unerreichte

und dieses Bildes mit nur kleinen Linsen anzuordnen ausgeführt worden. Das gegebene Paar von Crown- und Flintglas eine befriedigende chromatische Correction sich erreichen läßt,



The original Patent for the Planar dated 1896. This design by Paul Rudolph is for a lens that "corrects for astigmatism, spherical and chromatic aberration." Figure 1

were slightly more versatile. The front and rear lens halves could be used alone, therefore allowing three focal lengths with a single lens, which was not possible with the Planar. The Tessar lens, which appeared in 1902, achieved very good results in practice and was less expensive. Above all, it was considerably lighter.

In particular, the Planar lens was considerably more sensitive to bright light sources in the image due to its eight glass-to-air surfaces and unfavorable curvature. Antireflective lens coatings had not yet been invented. This meant that unwanted optical paths of several reflections in the lens created ghosts and glare in the image, because each glass-to-air surface reflected around 4% of the incident light.

It was not until the 1920s that optical designers resumed efforts to advance the double Gauss lens. Their primary objective was to increase its speed. In 1927, for example, Willy Merté at Carl Zeiss in Jena designed an entire series of lenses for 35 mm cameras and 16 mm movie film that had maximum apertures of $f/2$ and $f/1.4$.

These new designs entered the market under the name Biotar. Its design was very similar to the original Planar lens, but it abandoned the strict symmetry approach for the radii of curvature of the

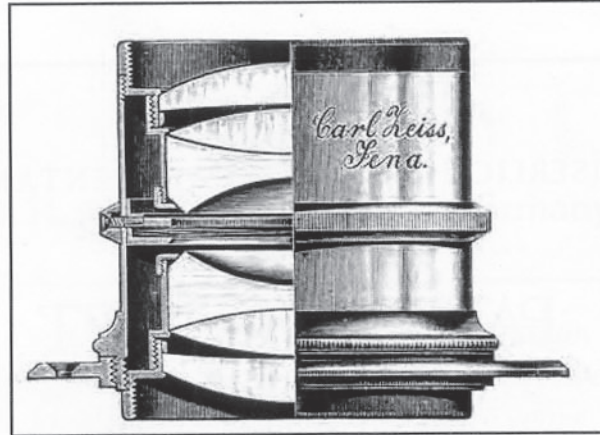

The original Planar design had six elements in four groups, arranged with strict symmetry around a central diaphragm. This one is an $f/3.8$ 160 mm lens. Figure 2

surfaces and the refractive indices of the glass materials and therefore achieved additional correction parameters.

Successors to the Biotar design

Nearly all of today's high-speed lenses with a medium field angle (50–100 mm focal length with 35 mm SLR cameras) are successors to the Biotar design. The number of variations is virtually endless. To achieve maximum apertures, one or two lenses were added to the classic six-element lens. The elements were combined into cemented components at a wide range of positions. Despite looking similar on the outside, there are major differences in performance between today's models (figure 5) and their pred-

ecessors, improvements that are largely attributable to the development of new glass materials.

While the highest refractive index with the Biotar design in 1927 was 1.673, forty years later designers could use glass with an index of 1.8 or even 1.9. A very high refractive index means that a lens can be given the same refractive power with flatter surface curvatures, reducing the aberrations caused by the spherical shape. It is easy to imagine that this would be a desirable feature for designing high-speed lenses. However, extremely high-index glass materials alone

do not solve every problem; they actually create some drawbacks of their own, as they display high dispersion. This is why the development of lanthanum glass in the late 1950s laid an important foundation for continued progress. With their medium refractive indices, they offer favorable dispersion properties and are ideal partners for high-index glass materials. As with all other lenses, Planar lenses also reaped the benefits of the advancements made in glass technology, which, in turn, kept an old idea young at heart.

The Gauss models designed at Carl Zeiss Oberkochen never used the Biotar name, but kept the older Planar brand name for historical and political reasons.

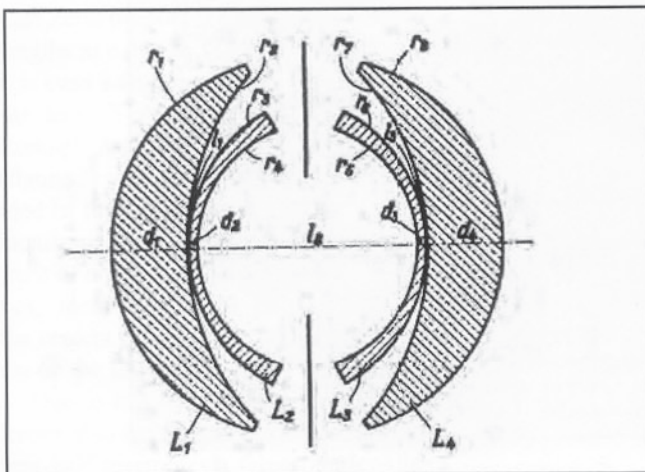

The Topagon $f/4$ 25 mm wideangle lens (this one was for the Contax) was Paul Rudolph's modification of the symmetric Gauss design. It used two different glass types. Figure 3

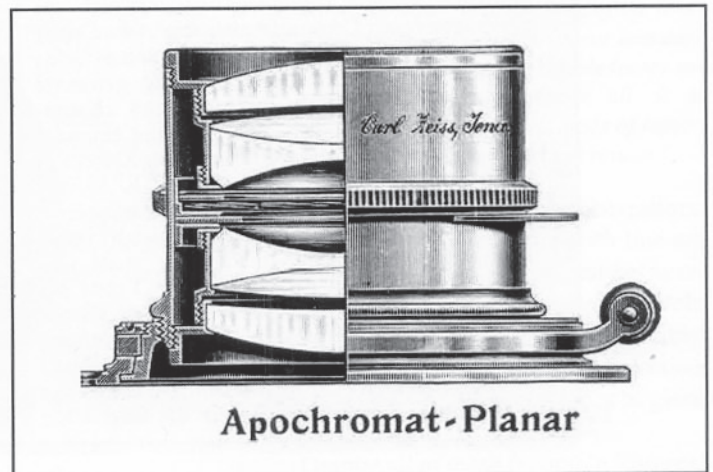

The Planar optimized for reproducing line originals in graphic-arts applications was called "Apochromat" because of its superior correction for chromatic aberration. Figure 4

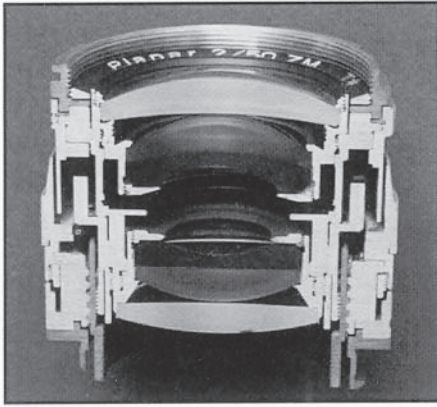

A modern Planar. The f/2 50 mm ZM is a design to be used with the Zeiss Ikon rangefinder camera. Figure 5

When the Carl Zeiss company was divided into an eastern part (Jena) and a western part (Oberkochen), these two new companies manufactured similar products and were embroiled for several years in legal conflicts about the use of trademarks. And since Carl Zeiss Jena lodged a claim to use the brand name Biotar, Zeiss at Oberkochen used the name Planar. Both lens names can be found on the twin-lens Rolleiflex cameras made in the early 1950s, as lenses for these cameras were delivered from both east and west back then.

At Carl Zeiss Oberkochen, the Planar was also a five-element Gauss model, which, thanks to advancements in glass technology, was invented to simplify the design without compromising performance. In Jena, this type of lens was called the Biometar.

The five-element Planar model enjoyed notable success in various camera formats, from the wide angle f/3.5 35mm version for the Contax rangefinder camera to the f/3.5 135 mm model for the 9×12 cm large-format field camera (figure 6). In particular, a number of exceptional pictures were taken with these optics during the heyday of the twin-lens SLR camera. It also serves as a wonderful example demonstrating that image quality is not merely enhanced by increasing the number of lens elements; there was also a seven-element Planar model for the 6×6 cm format, yet it was not better. In fact, more optical efforts are needed, as the design conditions for a camera with a swing-up mirror are

slightly less favorable than those for a rangefinder or large-format view camera that permits a shorter back focal length (the distance of the rear lens element from the image plane).

Success was slow in coming

Looking back, you could say that the success of Paul Rudolph's invention was slow in the making. In the 1930s, the Sonnar was considered the first really suitable high-speed standard lens for 35 mm photography, which was still in its infancy. However, after Alexander Smakula invented antireflective lens coatings at Carl Zeiss in Jena in 1935 and their broad usage after the end of World War II, it was possible to tap into the full potential of the double Gauss lens without any negative "side effects", and outstanding lenses were created for a wide range of applications.

Impetus of Stanley Kubrick

The Planar f/0.7 50 mm lens from the 1960s (figure 7) is a famous example of the possibilities of this lens type to gain speed, and it holds a world record in photography. The lens delivered an image that was four times brighter than with today's standard f/1.4 50 mm lens, and it was originally developed for NASA to take pictures of the dark side of the moon. Its fame skyrocketed when the legendary film director Stanley Kubrick pushed the envelope on his quest to give

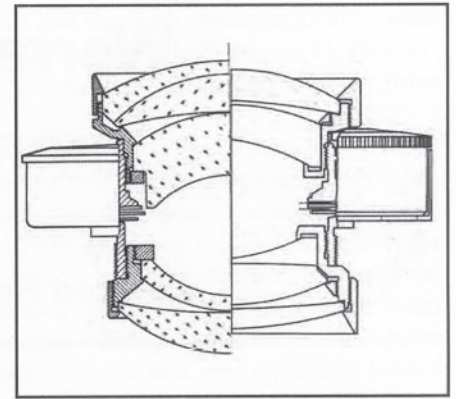

Two versions of a five-element Gaussian Planar made possible by improvements in glass technology. They are an f/2.8 80 mm lens (left) and an f/3.5 75 mm lens (right) for the 6×6 format. Figure 6

his film "Barry Lyndon" a unique look, by insisting on filming several scenes in candlelight. In 2011, one of these lenses was auctioned off for 90,000 euros.

Unfortunately, it is practically impossible to adapt this "dream lens" to an SLR camera. It had an image circle diameter of 27 mm (almost the APS-C format), a diameter of around 90 mm and weighed in at 1850 grams. And the large lens-element diameters had to come very close to the film plane — the distance to the last lens vertex was only 5.3 mm. It was therefore fitted with a central shutter for large-format-camera optics and was precisely adjusted to a modified Hasselblad body. □

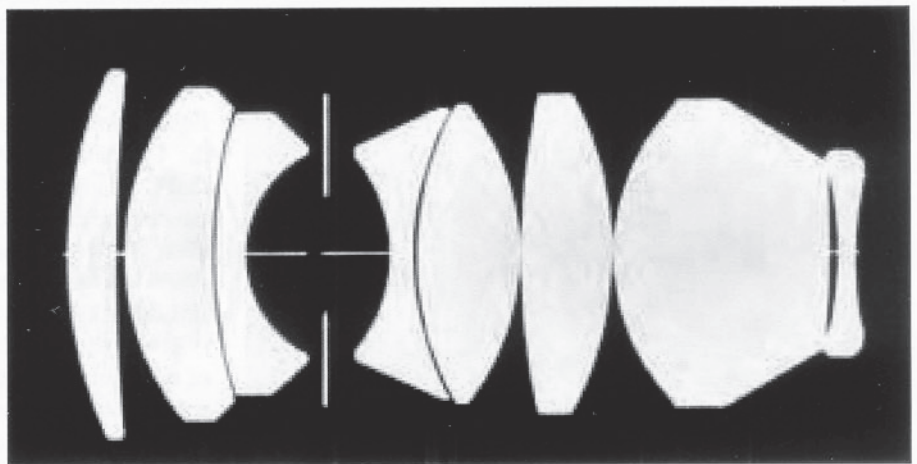

Claimed to be the world's fastest camera lens, this Planar-type f/0.7 50 mm lens was designed for NASA in the 1960s. The distance from the rear lens surface to the film plane was too small to allow space for a reflex mirror, so the lens was given a central shutter and put in a modified Hasselblad body. Figure 7

Werra – the design miracle from Eastern Germany

Manfred Herrmann, Frankfurt am Main, Germany

*This series of cameras from the
Deutsche Demokratische Republik represented an excellent combination
of elegant design and simplicity of use.*

The Werra camera has been well studied recently, and at first I did not intend this article to add much to our knowledge. I simply wanted to pay tribute to one of the most beautifully designed cameras ever made. However, in the course of researching and gathering data, I gained further knowledge, some details that had not been mentioned previously. You can find most of these findings in the Table called “The green Werra for completists” on page 11.

What makes this camera so special? Though beauty is in the eye of the beholder, there are some commonly recognized standards with regard to appearance, according to which the Werra is seen to be a perfectly integrated product. For that very reason at least one Werra is part of many of my fellow collectors' camera collections. What sets the Werra apart from the many innovative cameras of the period? It is the uncompromising simplification of the basics of taking a picture. Despite the almost total lack of visible knobs or levers, the camera has all the controls you need. The truly innovative technical feature is that the device to cock the shutter, which also forwards the film, is housed in the unobtrusive ring that encircles the rear of

This article first appeared, in German, in the journal *Photographica Cabinet* 50 (September 2010). The translation is by the author, whom we thank for permission to publish this version.

the lens barrel. Also, aperture, shutter speed and focusing controls are revealed only when the lens cap has been taken off. This cap, when reversed, also serves as the lens shade – another smart technical highlight. These operating elements are all easily accessible, while those other features that are not immediately necessary for taking a photo have been moved to the bottom plate. For that reason the camera looks quite “cleaned up.” Its square-edged shape with its top and bottom plate bevelled edges adds to a very positive overall impression.

Here I will be addressing both form and function. The “design” is pleasing to the eye, while at the same time all the technical features are very successful. All operating elements are in the right place, operating the camera follows common sense, the viewfinder is placed friendly to the user's nose at the left side, the feel of the camera is right, and the green covering also feels comfortable.

Who made it, and why green?

Little is known about the creator of this innovative camera. In the German book “DDR Design” by Günter Höhne¹ we read that it was Rudolf (Rudi) Müller from Carl Zeiss Jena. Unfortunately he can no longer be interviewed as a contemporary witness, but we do know that as a manager at Eisfeld, where the Werra was produced, he had an engineering rather than a designer background.

It was indeed “Rumü” Rudi Müller who defined the concept of the Werra. (Although his given name was Rudolf he was always known as Rumü.) He was an avid sports photographer who wanted to build a people's camera. He discussed his plans with Paul Oswald, at the time head of camera assembly, after work. The talk turned to questions of color. Rumü had a Contax in lime green with dark green leather trim, and one in yellow with brown saddle-leather trim, with lenses matching the colors.

At the end of 1953, Carl Zeiss Jena received a commission

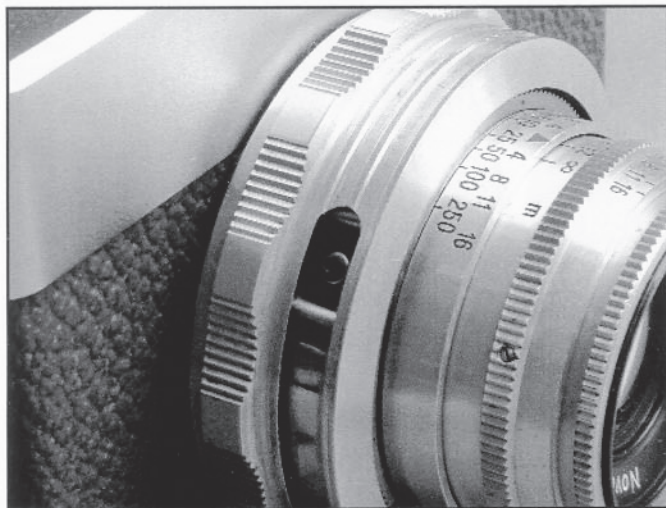

The flash synchronization socket was inside the aluminum lens ring on the first Werra. Figure 1

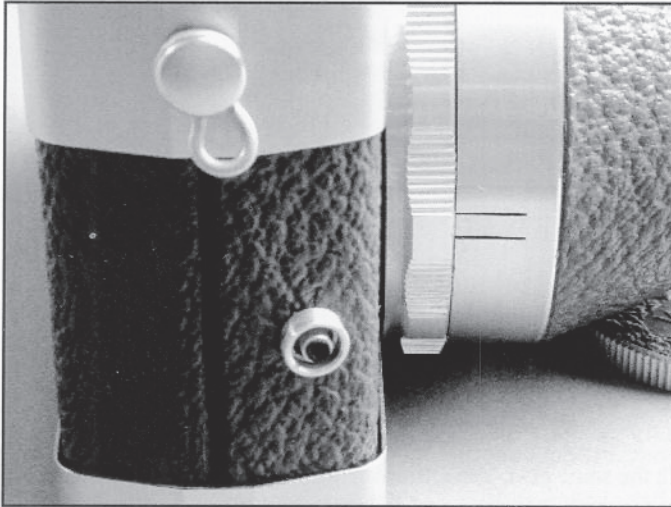

In later versions of the original Werra the flash socket was moved to the side of the camera body — and stayed there through all the later models. Figure 2

from the Ministry of Mechanical Engineering for an amateur film camera. They were asked to develop one that could be produced to sell at less than or equal to a hundred marks. The task was entrusted to what was called the F-operation, with Rumü as manager (he was, however, never head of the Eisfeld operation). So, for the camera designed under the F-Plan, Rumü's concept was for it to be easy to use, with a simple objective — for example the $f/3.5$ 50 mm three-component Novonar, or a better lens, perhaps a four-component design such as the $f/2.8$ or $f/3.5$ 50 mm Tessar. There would be a central shutter, no interchangeable lenses, and combined film transport and shutter cocking. For the new camera Rumü wanted green, and he emphasized that by having the machines in the production line painted green — hence the name, Rumü-green. (For more detail on how the F-Plan camera became the Werra, see *Photographica Cabinett* 54, December 2011.).

When the Eisfeld plant still existed, prior to the 1989 revolution and the fall of the East German regime, my fellow-collector Heinz Schrauf contacted it. The response he received was as follows: “The idea for the design ... especially as to the green versions, was a result of our landscape: Thuringia is the green heart of Germany, and a camera from the Thuringia plant should emphasize this fact by means of the green color.” This explanation, however, seems to be quite far fetched.

Unfortunately, in the course of its evolution the Werra shared its fate with that of many other products of acknowledged excellent design — when improvements were attempted the results were actually worse. And for good reasons this article deals with the green Werra cameras only.

The original Werra and the Werra I

On the first Werra from 1954 the lens ring for cocking the shutter and forwarding the film was not leather covered but was made with a ridged aluminum ring. (In fact, Werra cameras were never actually covered with leather but used vulcanite. I will continue to use the more traditional term.) And the very

first production batches had the flash synchronization socket on the lens ring and not on the camera body (figure 1). This version is relatively rare and for that reason gets a higher price among collectors.

My fellow collector Heinz Schrauf published an article² in *Click + Clack* (a magazine that was the predecessor of *Photographica Cabinett*) stating that this version was especially made for the Leipzig Fair in 1954. However, this cannot be true, for the camera with that feature in my possession has the serial number 23566, and instead of the more common Tessar it has an $f/3.5$ 50 mm Novonar bearing the lens serial number 4195874. Both numbers indicate that it is definitely from a batch production.

These first versions already show all the essential features that established the Werra design; the “cleaned up” appearance, with nothing redundant.

There was a later version that still lacked leather on the lens ring, but the flash synchronization socket was moved to the middle of the right side of the camera body (figure 2). From an operating point of view this is an improvement, and as to the design aspect, not a change for the worse.

The version we call the Werra I appeared in 1955, although it was not given that number in the early leaflet No. 54-086-1. The lens ring is now covered in olive-green vulcanite, which makes the overall impression more harmonious. Now the previously circular shaped neckstrap attachment is more trapezoidal, which matches better the overall square-edged camera appearance (figure 3). There is another tiny detail — one version of the neckstrap attachment is made of bent wire, the other one is made of stamped metal sheet.

While the first versions of the Werra were equipped with a simple flat glass viewfinder, the later ones had a more sophisticated bright-frame finder. For a collector it may be important to know that the simple viewfinder could be exchanged for the better version (see the *WERRA-ABC*,³ page 12). In its outward appearance the bright-frame finder looks more elegant and is therefore an improvement (figure 4). The various shutters make some impact on the appearance — the version with the Synchro-

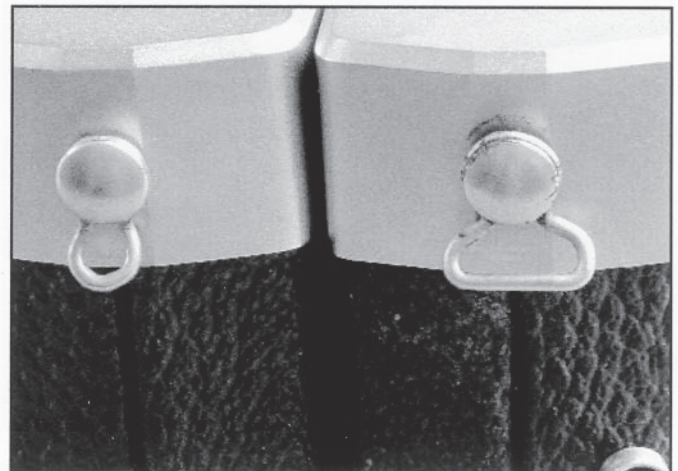

The neck-strap attachments varied from circular wire loops to a more trapezoidal shape. Figure 3

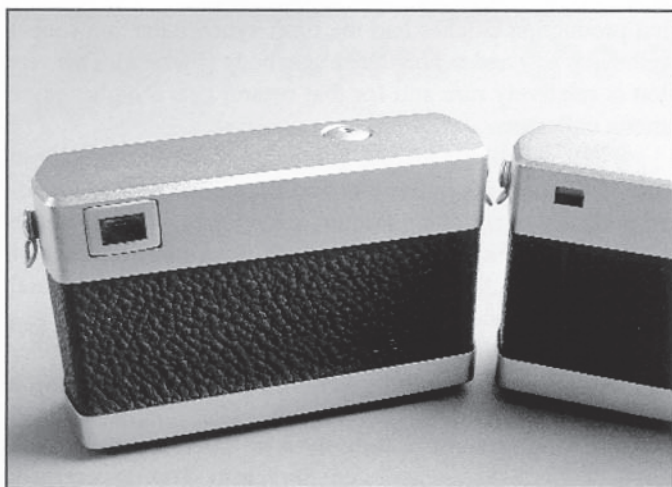

Two styles for the viewfinder eyepiece: Versions with plane glass (right), and with the bright frame (left). Figure 4

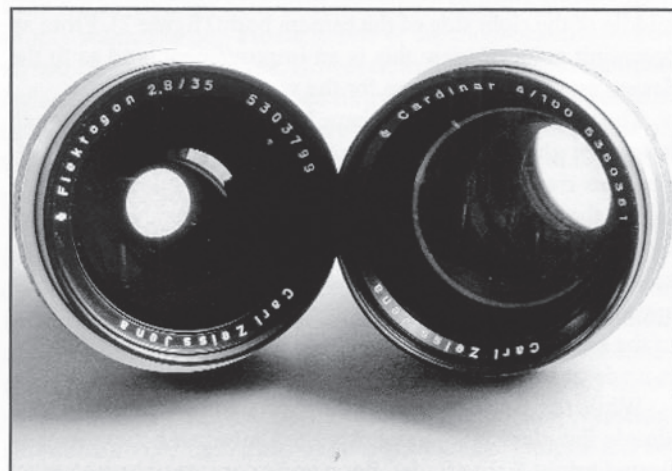

The two interchangeable lenses for the Werra III through V: the f/2.8 35 mm Flektogon on the left, and the f/4 100 mm Cardinar on the right Figure 5



This viewfinder eyepiece, starting with Werra III, has a ring that unscrews to make a clamp for an accessory shoe and also provides a diopter adjustment. Figure 6

Compur shutter looks somehow “tidier” than the one with the Vebur shutter, but the difference is slight.

The WERRA II

Starting in July 1958 we saw the Werra II, now equipped with the bright-frame viewfinder as a standard feature. In addition the camera had a built-in selenium exposure meter with two metering zones (for bright and dim light conditions) and an uncoupled “calculator”(see *WERRA-ABC*) as an aid for the user, on the back of the camera. The exposure meter fits harmoniously with the looks of the camera, and the “calculator” disc in matte chrome adds to the overall well done appearance.

The WERRA III

In the same year, 1958, the Werra III was launched. This version came with interchangeable lenses and a coupled rangefinder, but lacked the Werra II exposure meter. The only interchangeable lenses during the whole lifecycle of the Werra cameras were the six-element wide-angle f/2.8 35 mm Flektogon and the five-element f/4 100 mm Cardinar (figure 5). Despite the leaf shutter both lenses were full-fledged complete lenses, not those designs where only the front element was interchangeable, as for example on the contemporary Contaflex from Zeiss Ikon Oberkochen. This engineering achievement would have served the “capitalistic” competitors in the West very well.

Frames for the two additional focal lengths were visible in the multi-frame viewfinder. The lenses had a special bayonet mount that locked the lenses by means of a ring. The eyepiece now has a diopter adjustment and is no longer rectangular but round (figure 6). However, the ability to adjust it according to the photographers’ eye somehow disappears if it used to attach the by-now available shoe for accessories. (I do not know whether this attachment was already available for the green Werra cameras, but I do remember that I had it with the black Werra I that was my camera in the Sixties).

The interchangeable lenses required more space; hence the lens’ previously conical shade is now somehow bulgy, as you can see on the illustration on the back cover of this issue. The release button is shiny and not matte chrome as before. Despite the changed size and shape of the lens hood/lens cap the overall appearance is still very harmonious.

The Werra IV

My favorite, the Werra IV, is certainly a milestone among the Werra cameras. It was launched in November 1958, and unlike the Werra III it has the built-in selenium exposure meter. This meter, to quote from the above-mentioned book *WERRA-ABC* “...is different from the meter in the Werra II in that the settings for shutter and aperture happen simultaneously.” The device on the back of the camera is no longer required.

All other visible operating devices are the same as for the Werra III. With regard to its technical standards the Werra IV is on a par with its contemporary, the Retina IIIC – but from an appearance point of view it is to be rated much more favorably. (Note: For the Kodak Retina IIIC, the Zeiss Ikon Contaflex and some other contemporary cameras, only the

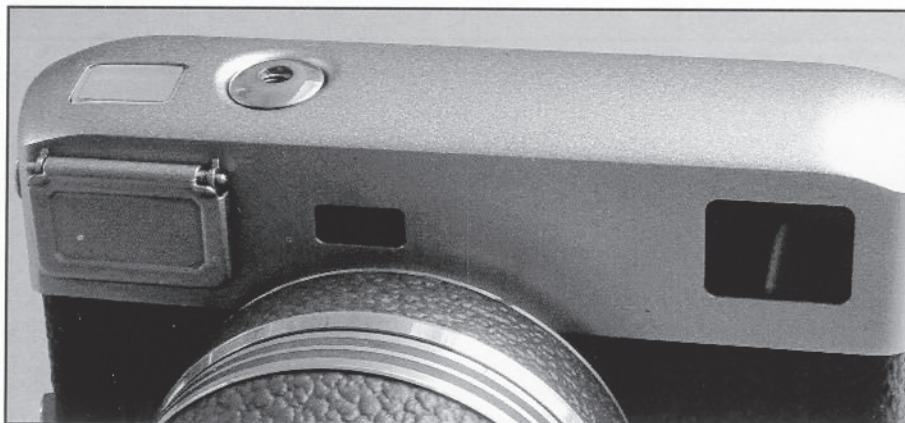

The top plate of the Werra V with the window through which one can read the built-in selenium exposure meter. Figure 7



The Werra logo as it appeared on the green Werra cameras only. Figure 8

front element of the lenses are interchangeable, which resulted in extremely bulky tele and wide-angle lenses).

The Werra V

From an engineering viewpoint, the Werra V that was launched in 1960 was without any doubt the most perfect version of the Werra camera family. It was “automatic” in the way this was

understood at that time, meaning that shutter speed and aperture were coupled; hence it was not necessary to read and set the metered data separately.

In addition, the meter needle, aperture and shutter speed were all visible in the multi-frame finder. Perhaps for this reason more space was required, and hence the top plate is no longer flat but slightly arched.

But from an appearance point of view, this version should be judged poorer than the Werra IV. The bevelled edges were abandoned for the top plate but kept for the bottom plate. The extra window in the top plate for the exposure meter has become redundant and is now being used to illuminate the needle reading in the viewfinder (figure 7).

All the other operating features are identical with those of the Werra IV, and despite the new top plate the Werra V is well done according to, again, appearance considerations.

The Fall

Starting at 1961 with the Werra 1 (Werra 1C – see Hartmut Thiele’s booklet *Die Geschichte der Kamera von Carl Zeiss Jena* – the history of cameras made by Carl Zeiss Jena⁴) we saw a development that in German is called *Verschlimmbesserung*. A close English translation could be “The cure was worse than the disease.” The innovative olive green – some manufacturers called it “safari” green – was changed to a dull black, and it got worse. A black serrated plastic covering succeeded the vulcanite; the previously crisp and clear top plate that had only, depending on the camera type, the viewfinder window and/or the window for the rangefinder or the exposure meter, got stripes, and there appeared a rather useless bezel (see figure 8 in Joachim Arnz’s article in *Zeiss Historica*, 34/2, Fall 2012). The Werra lettering that had been embossed on the back and looked quite distinguished (figure 8) is now shown on the front side by means of a cheap plastic inlay (figure 9).

The functional design as described above may have been preserved, but from a serious appearance point of view all of this was deterioration. The author Günter Höhne, mentioned above, supports my opinion. On his website he says about the black Werra cameras “An advancement of the 1957 Werra while losing its former creative quality.” Nothing needs to be added

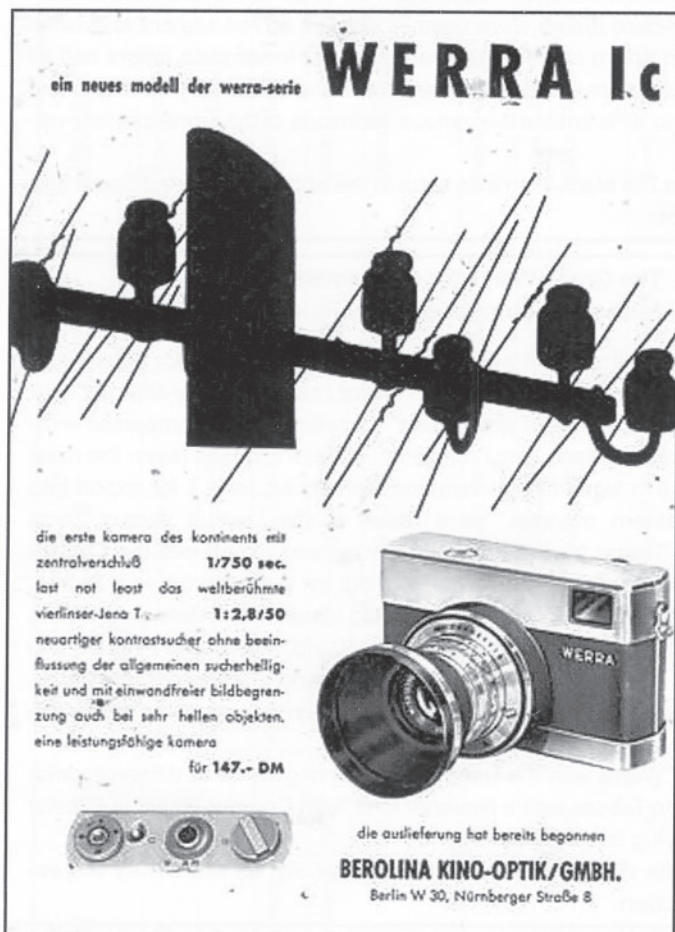

An advertisement for the black Werra 1c, with the logo now moved to the front of the body. Figure 9

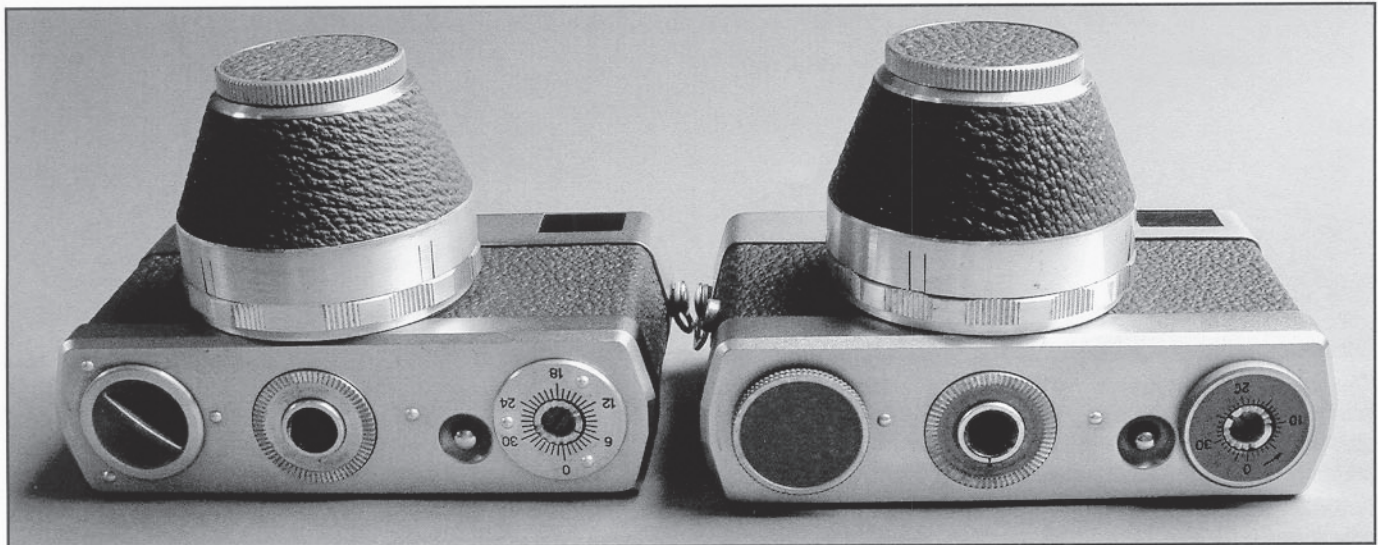

▲ **Two different versions** of the bottom plate for the Original Werra. Figure 10

to this statement, and therefore my design contemplation comes to an end with the green Werra V.

Acknowledgements

I thank my fellow collector Michael Eberhardt of Bayreuth who lent me some of his early Werra cameras for this article. I also thank Heinz Schrauf from Solingen for copies of his Werra articles in the collectors’ magazine *Click + Clack*, a predecessor of *Photographica Cabinett*, and last but not least the collectors Hartmut Thiele and Günter Rödinger, who willingly provided me with detailed information in lengthy phone calls. I owe very special thanks to my fellow collector Stefan Köser, who not only took the photograph on the back cover but also edited my Werra photos for this article.

References

1. *DDR-Design*, Günter Höhne, Komet Verlag GmbH, Cologne.
2. *WERRA-ABC*, VEB Fotokinoverlag Halle (Saale), 1st Edition 1960.
3. “Werra,” in *Die Geschichte der Kamera von Zeiss Jena*, Hartmut Thiele, 5th revised edition, 2007. Privately printed in Munich.
4. *Werra – die Kamera mit dem besonderen Dreh.* (“The camera with a special turn”) Contribution from Heinz Schrauf, Solingen.

© Manfred Herrmann, Frankfurt, Germany 2013 □

The Werra Typography

From many of the original brochures we see that the green Werra cameras were identified by Roman numbers, whereas the succeeding black versions had either Arabic or no numbers at all, but with a suffix such as “mat.” In addition to the number, sometimes lower-case letters were used, – see the advertisement shown in figure 9. For the green Werra cameras neither upper nor lower case letters can be found in the original literature – these appear only in the secondary literature and are most likely meant to differentiate the various variations of the same camera version.

But the headline for the black Werra as seen in the above mentioned figure also bears a Roman number.

**The Green Werra for Completists –
the dedicated counters of every little screw**

Though dispensable and irrelevant with regard to appearance, but for the sake of completeness, I should mention that the green Werra I came in many different variations – different shutters, different viewfinders, sometimes with, sometimes without self-timer and X- and M flash synchronization, different lenses (even the most common Tessar came in two different versions, namely as Jena T for export into the “capitalistic” Western markets, as a result of the lawsuit versus Zeiss Oberkochen, and as Tessar for the domestic market and export into the COMECON markets). Following the mathematical formula for the factorial, $n! = 2 \times 3 \times 4$, all these variations of the green Werra I alone would result in 24 different variations (four shutters, namely Synchro-Compur, Compur-Rapid, Vebur and Prestor, two different viewfinders, namely the flat glass viewfinder and the bright-frame finder, three different lenses – Novonar, Tessar and Jena T – not to mention further differences such as the varying base plates (figure 10).

Even the Original Werra with the uncovered lens ring came in different variations – with Jena T and Tessar, with a Novonar lens, with Compur-Rapid or Prestor shutter, and with varying base plates.

The table opposite demonstrates this huge variety, as shown by the examples in my collection.

See overleaf (page 12) for examples of all the green Werras, assembled on a single page

Type	Year	Body Number	Lens	Lens Number	Shutter	Viewfinder	Miscellaneous
Original Werra	1954	23566	Novonar 3.5/50	4195874	Vebur 1-1/250	Flat glass	Flash Synchronization Socket in Lens Socket Ring, circular neck strap attachment
Original Werra	1954	39408	Novonar 3.5/50	4212252	Vebur 1-1/250	Flat glass	Flash Synchronization Socket in Lens Socket Ring, circular neck strap attachment
Original Werra	1954	47256	Tessar 2.8/50	4272163	Vebur 1-1/250	Flat glass	Flash Synchronization Socket in Lens Socket Ring, circular neck strap attachment
Original Werra	1959	59568	Jena T 2.8/50	5788556	Vebur 1-1/251	Flat glass	Uncovered lens socket ring, trapezoid neck strap attachment stamped metal sheet
Original Werra	1954	59713	Jena T 2.8/50	4516258	Compur-Rapid	Flat glass	Uncovered lens socket ring, trapezoid neck strap attachment bent wire According to Thiele this camera should have a Vebur shutter
Werra I	1955	150810	Tessar 2.8/50	4598677	Synchro-Compur	Flat glass	Trapezoid neck strap attachment bent wire; VXM-engraving not black
Werra I	1957	182490	Tessar 2.8/50	4620362	Vebur 1-1/250	Flat glass	Trapezoid neck strap attachment stamped metal sheet
Werra II	1958	201306	Tessar 2.8/50	4638153	Vebur 1-1/250	Bright-frame	The inside surface of the back is engraved "1. 10/2803 MADE IN GERMANY." According to Thiele this lens was for a Werra I
Werra I	1955	204733	Jena T 2.8/50	4354229	Synchro-Compur	Bright-frame	Trapezoid neck strap attachment stamped metal sheet, a sticker "Color Prohasselk Duisburg" is inside the camera
Werra I	1954	211575	Tessar 2.8/50	4535154	Vebur 1-1/250	Bright-frame	Trapezoid neck strap attachment bent wire; the device for opening and closing the back plate is shiny, not matte chrome
Werra III	1962	221057	Tessar 2.8/50	6509110	Synchro-Compur	Bright-frame	According to Thiele this camera should have a Prestor shutter and a black body; interchangeable lens possibly from another Werra camera
Werra III	1958	275508	Tessar 2.8/50	5684213	1-1/500 Prestor RVS	Bright-frame	Except for the shutter identical with the above Werra III; VXM-engraving black
Werra IV	1959	293898	Tessar 2.8/50	5725674	1-1/500 Prestor RVS	Bright-frame	See text, pp 8-9.
Werra II	1958	299721	Tessar 2.8/50	4627312	Vebur 1-1/250	Bright-frame	Identical with Werra II No. 201306
Werra I	1954	300445	Tessar 2.8/50	4539356	Synchro-Compur	Bright-frame	According to Thiele this camera should have a Vebur shutter; no interchangeable lens, hence it is unlikely that the lens is from another Werra
Werra IV	1958	302302	Tessar 2.8/50	5279499	1-1/500 Prestor RVS	Bright-frame	Identical with Werra IV No. 293898
Werra V	1959	303877	Tessar 2.8/50	5722857	1-1/500 Prestor RVS	Bright-frame	According to Thiele this Tessar lens was for a Werra II, III or IV, but not for a Werra V; this interchangeable lens is possibly from another camera
Werra I	1954	311086	Tessar 2.8/50	4537467	Vebur 1-1/250	Bright-frame	Trapezoid neck strap attachment stamped metal sheet
Werra I	1959	311376	Jena T 2.8/50	5788519	Vebur 1-1/250	Bright-frame	Except for lens identical with No. 311086
Werra I	1959	314956	Tessar 2.8/50	5784396	Vebur 1-1/250	Bright-frame	The body number is now inside the camera, not below the lens barrel but below the spool, and not silvery; apart from that identical with No. 311086

The Green Werras all on one page



Original Werra

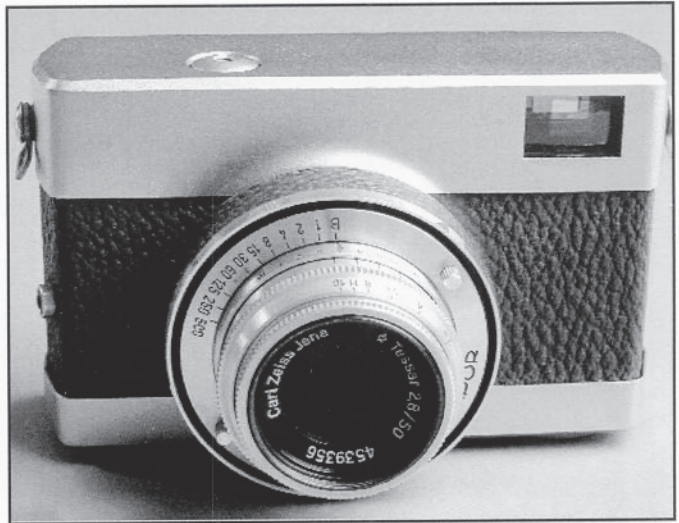

Werra I

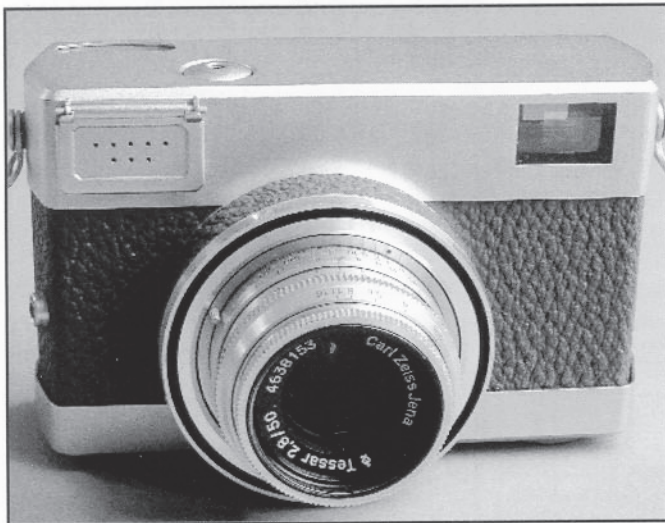

Werra II



Werra III



Werra IV



Werra V

The Aseros

Larry Gubas, Las Vegas, Nevada

Before World War II Zeiss made this special zoom telescope for use on a table stand, on a tripod, or in the hand.

The telescopic products of Carl Zeiss Jena are especially valued by contemporary collectors. A week before I wrote this description of the Aseros, a copy of the 1928 Zeiss telescope catalog sold on

eBay for \$341. It is a 48-page collection of the major civilian telescopes of the era. Two pages of the catalog (figure 1) show an instrument incorporating what seems to be a unique concept for the era—a

zoom lens built into the telescope's body. This versatile instrument, the Aseros, can be used as a hand-held instrument, with a special table stand or with a tripod, and it was priced considerably less than





ASEROS

- 1 Table stand with tripod foot
- 2 Socket fitting
- 3 Clamp screw for side motion
- 4 Clamp screw for altitude motion
- 5 Sleeve clamp screw
- 6 Objective cap
- 7 Extensible dew cap
- 8 Revolving collar for setting telescope to required magnification
- 9 Revolving collar with dioptric scale for setting eyepiece to observer's vision
- 10 Attachable yellow glass



Fig. 2. Aseros used as a hand telescope 9102
Magnification continuously variable without interrupting observation



Fig. 3. 9100
Aseros in case

10



ASEROS

1 1/8 inch (48 mm.) Portable Telescope. Magnification continuously variable between 4X and 20X

This is one of the most compact Zeiss telescopes. A movable erecting system of lenses, actuated by a revolving collar (8 in Fig. 1), furnishes a means of conveniently varying the magnifying power. As the magnification is increased, the view appears to approach the eye by a continuous motion, until the highest magnification of 20X is reached.

The variability of the magnification favours the use of the Aseros for many purposes such as hunting, sailing, and other sports. One of the many satisfied owners of an Aseros is an Eskimo in Alaska who uses it for hunting sea otter. As for astronomical observation, it is interesting to watch, on moonless nights, the fainter stars come into view and seem to approach as the magnification is increased. With the highest power, of 20X, it is possible to recognize stars of the ninth magnitude.



Fig. 4. Aserosta 9103

Prices on accompanying price sheet

Telescope for use in hand, in leather case (Figs. 2 and 3) Aseros

Same, with metal table stand and adapter (Fig. 1) Aserais

Same, with light wooden tripod and adapter Aseraras

Same, with extra strong wooden tripod and adapter (Fig. 4) Aserosta

A. Metal table stand (Fig. 4) Starumeno

B. Light wooden tripod Aserraste

C. Extra strong wooden tripod Starudor

Adapter for table stand and tripod, in leather case Aserramos

Yellow glass for use in intense light Aserrar

Sight correction lens Aserraria

Sun glass and objective sunshade Assignen

When ordering state Code words:

Magnification	Objective		Exit pupil diameter	Light transmitt. power	Field of View		Weight			Length of Telescope
	Diameter	Focal length			Angular	Linear at 1000 yds.	Telescope	Case	Stand	
	in.	in.	mm.		degrees		lb.	lb.	lb.	in.
continuously variable between 4X and 20X	1 1/8	9	11.5 to 2.4	132 to 6	12.5 to 2.5	240 to 47	4.2	2	A: 6.2 B: 3.3 C: 10	20 1/2

11

Two pages from the 1928 Zeiss telescope catalog. Figure 1

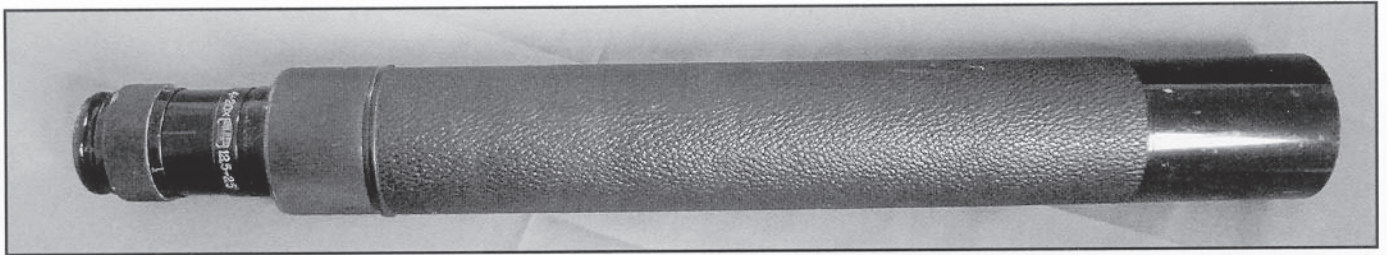

The Aseros telescope at its full length. The focusing adjustment is next to the eyepiece at left; and zooming is controlled by the ribbed ring just short of the leather-covered telescope tube. Figure 2

a full telescope with multiple eyepieces and a fixed objective. Its manufacture continued through the 1930s, but after World War II neither the new location in

Oberkochen, nor the former factory that was taken as war reparations in Jena, considered making it when other manufacturing was resumed. In fact, most of the

civilian astronomical products were dropped in Oberkochen and only limited smaller astronomical products were resumed in Jena. Both organizations decided to concentrate on the much larger products that were required by governments and universities, where profitability was assured via a contract, rather than the amateur products where profitability would be dependent on the number of instruments that could be sold. So this remarkable device and the other similar devices in the other 46 pages of the catalog were no longer marketed, and they are quite rare and valuable today.

I have seen only two of these telescopes, and the images shown here are of the one that is in my collection. However, I did notice that there was a very slight difference in the eyepiece when I had the two examples side by side. The first one had a rounded eyepiece that did not accept the yellow filter for situations with a lot of glare, but the second had a different fitting that easily accepted that filter. It is an example of the detail that went into preparing such a product for market.

The view through the eyepiece could be varied from 4× to 20× with a corresponding field of view from 12.5° to 2.5°, and this could all be done with a twist of the wrist without moving the instrument from its operating position.

The telescope has a total brass body with a leather covering over the non-moving area plus a built-in adjustable sun shade. It is certainly a well conceived and practical instrument with three different means of support: a table stand and two different tripods with an adapter to attach to the instrument. The cost of the telescope itself in the 1934 price list was \$210. The term “Aseros” was merely a special name to facilitate ordering via telegram. □

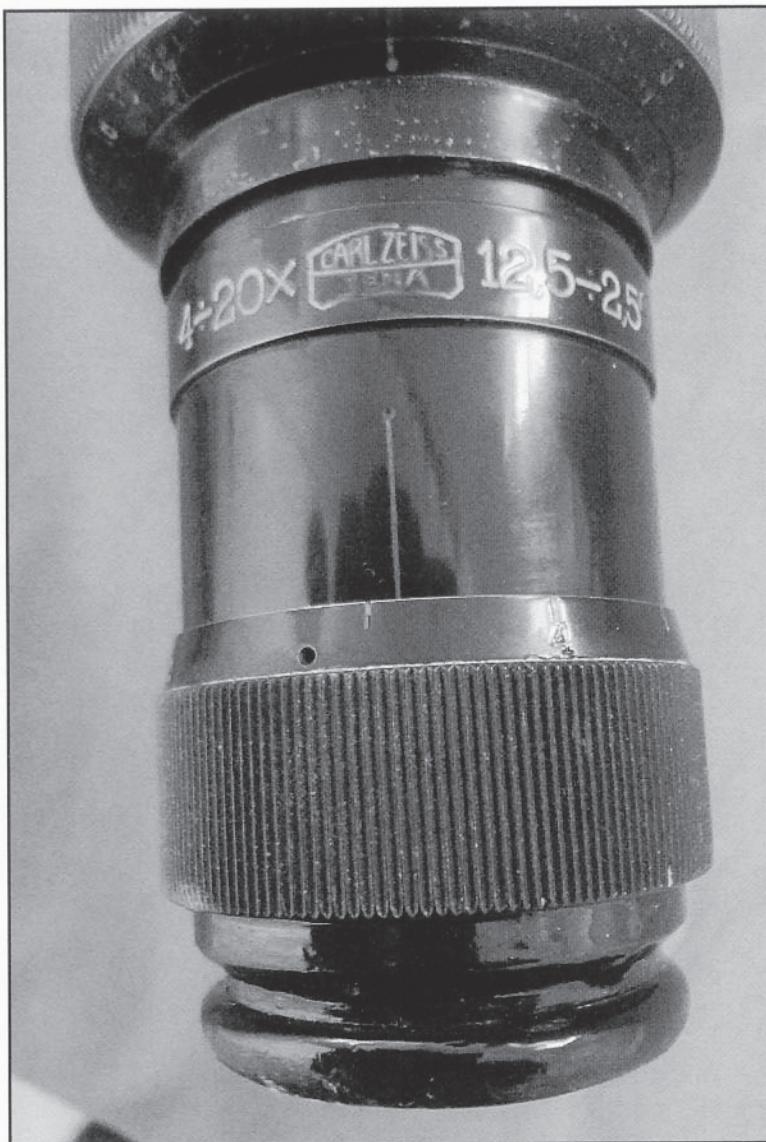

The eyepiece area, with focusing at the bottom, the 4× to 20× zoom range indicated, and the zoom control ring at the top. Figure 3

Cross-references to catalogues, price lists or collectors' literature is not only helpful for collectors who want to learn about more specific cameras but are also reference for the book itself. Last but not least, the first chapter – which one could say helps us get in the mood for this book – describes the history of Zeiss cameras from 1902 to 2012 with four-color images of rare and beautiful Zeiss cameras.

While this section of the book is trilingual, in German, English and Japanese, the pages describing the 220 cameras are all in German. However, an appendix shows a one-page translation of the various technical terms that enables the Eng-

lish-speaking reader to easily understand all descriptions. And for those who need more assistance, a transparent template is available on request that can be laid over the page and from which a reading of the corresponding English (technical) terms can be taken.

And to whom is this reference book addressed? Well, actually to every collector. Due to the variety of Carl Zeiss cameras with regard to number of manufacturers and camera types, any collector with one or many Zeiss cameras will need this Register for their complete identification. But the book also addresses those collectors who collect cam-

eras with regard to a certain film format or technical feature. Or simply because the reader wants to get informed about an important and interesting part of German camera history.

An interview with the author, held 9 March at Frankfurt in Germany.

The interviewer – himself a Zeiss collector – and his subject have known each other for many years and had jointly published the article “Was the Leica II a lightweight?” in the British collectors' magazine *Photographica World* No. 115 and in the German collectors' magazine *Photographica Cabinet* No. 34.

Manfred Herrmann:

What made you tackle this task, and what were your initial thoughts?

Bernd K. Otto:

It was at the beginning of the 1970s when I started collecting cameras. My first camera was a Box Tengor 4.5x6 cm. This step was the key moment, the “release button” in the truest sense of the word. I already felt strongly that Zeiss must be something special.

At that time I became acquainted with Kurt Jüttner; we had met at flea markets and bric-a-brac markets where we were hunting for cameras. We found out that we were both also interested in jazz, my other hobby, and alas – there was a common cut-set. After becoming aware that although there was plentiful literature about the Leica, there was hardly anything about Zeiss, in 1983 we published jointly the post-war register of Zeiss Ikon cameras made from 1945 to 1975.

But I already had the idea that this register should be expanded to the year 1926 – the year of the merger of several well-known camera manufacturers.

For many years this idea remained idle, but by the beginning of the 1990s the decision had matured sufficiently to do it. Kurt Jüttner, however, was heavily busy with his job, and also had sold most of his camera collection – without his records the camera register could not have been achieved.

The project languished for a few



**VEB Zeiss Ikon,
Dresden &
Kamera-Werke,
Niedersedlitz**

Reg.-Nr.: 32.6.24



Name: Contax FBM (Pentacon FBM) **Abmessungen mm:** 148x95x65
Bestellnummer: **Gewicht g:** 700 (Gen.)
Film: Kleinbildfilm 135 **Bildformat:** 24x36 mm
Typ: einäugige Spiegelreflexkamera **Stückzahl:**
Buchstabencode:

Registervariante	32.6.24.1	32.6.24.2	32.6.24.3
Bestellnummer	1957 - 1900	1957 - 1900	1957 - 1900
Geliefert von bis	1957 - 1900	1957 - 1900	1957 - 1900
Optik	Tessar (autom. Springbl.)	Biotar (autom. Springbl.)	Primotar E (Druckbl.)
Lichtstärke/Brennweite	2,8/50 mm	2,0/58 mm	3,5/50 mm
Hersteller	VEB Carl Zeiss, Jena	VEB Carl Zeiss, Jena	Meyer Optik, Götting
Optiktyp	Triplet-Anastigmat	symmetrischer Doppelt-Anastigmat	Triplet-Anastigmat
Linienzahl	4	6	4
Blendenbereich	2,8 - 16	2,0 - 16	3,5 - 22
Entfernungsbereich	0,5 m - ∞	0,5 m - ∞	0,5 m - ∞
Entfernungseinstellung	Gesamtobjektiv	Gesamtobjektiv	Gesamtobjektiv
Objektivanschluss	Schraubgewinde M 42 x 1	Schraubgewinde M 42 x 1	Schraubgewinde M 42 x 1
Filteranschluss	S 49 Ø, A 51 Ø	S 49 Ø, A 51 Ø	S 40,5 Ø, A 42 Ø
Verschluss	VEB Zeiss Ikon, Dresden	VEB Zeiss Ikon, Dresden	VEB Zeiss Ikon, Dresden
Verschlussart	Tuchschützverschluss	Tuchschützverschluss	Tuchschützverschluss
Zeitbereich	B, 1 - 1/1000 Sek.	B, 1 - 1/1000 Sek.	B, 1 - 1/1000 Sek.
Blitzanschluss	Kabelkontakt	Kabelkontakt	Kabelkontakt
Vorlaufwerk	ca. 10 Sok.	ca. 10 Sok.	ca. 10 Sok.
Verkaufspreis	654,- DM 2.58 (Pentacon), 463,- DM 1.59 (Pentacon)	784,- DM 2.58 (Pentacon), 602,- DM 1.59 (Pentacon)	600,- DM 2.58 (Pentacon), 420,- DM 1.59 (Pentacon)

Gehäuseart Ganzmetall-Spritzguss, mit angelenkter Rückwand

<input type="checkbox"/> Zubehörschuh <input type="checkbox"/> Stativgewinde englisch 1/4" <input checked="" type="checkbox"/> Stativgewinde deutsch 3/8" <input type="checkbox"/> Hümmenachse <input checked="" type="checkbox"/> Filmtrennschnecke <input checked="" type="checkbox"/> Filmtrennschraube <input checked="" type="checkbox"/> Filmtrennschneidwerk <input type="checkbox"/> Filmtrennschneidwerk <input checked="" type="checkbox"/> Rückspulwerk	<input type="checkbox"/> Rückspulspringkurbel <input checked="" type="checkbox"/> Zahnwerk 1-36 <input type="checkbox"/> Zahnwerk 36-1 <input type="checkbox"/> Zahnwerk (Schichtenstar) <input checked="" type="checkbox"/> Doppelblendeoptore <input checked="" type="checkbox"/> Drahtkurvenverschluss <input type="checkbox"/> Auslöseverriegelung <input type="checkbox"/> Belichtungsabelle <input type="checkbox"/> Batterieschaltung	<input type="checkbox"/> Gehäuse Holz <input checked="" type="checkbox"/> Gehäuse Metall <input type="checkbox"/> Gehäuse Kunststoff <input checked="" type="checkbox"/> Gehäuse verchromt <input type="checkbox"/> Gehäuse schwarz <input type="checkbox"/> Gehäusebesagelst Leder <input type="checkbox"/> Gehäusebezugsstoff Kunstleder <input type="checkbox"/> Laufbodenröhre <input type="checkbox"/> Radialbelvorstellung
--	--	--

Anstattung Vorgefertigt auf der Leipziger Frühjahrmesse 1957. Baugleich mit Contax FB / Pentacon FB, jedoch zusätzlich mit Zeiss-Messleupe (Schnittbild E-Messer), für den Export wurde die Contax FBM als Pentacon FBM graviert. Kamera wurde ab 1957 vom VEB Kamera-Werke Niedersedlitz, Dresden, gefertigt. Umbenennung dieses Werkes: 1959 in VEB Kamera- und Kinowerk, Dresden, ein Vorläufer des VEB Pentacon, Dresden (1994).

Sucher Spiegelreflex, Prisma fest eingebaut, Mattscheibe mit hellem Sucherbild mittels Feldlinse **Wechselobjektiv:** 25 bis 1000 mm

Sonstige Ausstattung / Zubehör Entfernungsmessung über Mattscheibe, zusätzlich „Messleupe“ (Schnittbild), ungekoppelter Selenbelichtungsmeßer, über dem Deckkristall aufgebaut, Messbereich ab 1,5 Lux, 9-27 DIN, Roll-Kontrollle über Skala auf der Kamerablende über dem Deckkristall, zwei Sternvorätze

Qualitätsnachweis:

Prospekt

Gebrauchsanleitung 158/21AG 12.57, II-9-141 Ag 60, II/9/105 Ag 60

Preisliste

Katalogabbildung

Buch / Zeitschrift „Die Fotografie“ 6.57

237

A sample page from the book — the Contax FBM (or Pentacon FBM)

years. Computer-based support by applications such as Excel and word processing was still not available, and to finalize the project by means of a typewriter would have become a nightmare.

But finally my ambitions took hold, and by now I felt them more than ever, because I had already invested so much time and effort toward this project. It helped that I had established contact with Rudi Hillebrand, the editor of the well-known camera collectors' magazine *PhotoDeal*. He encouraged me to go "electronically," that is, to use a personal computer. And after that there was the logical next step – to include all camera manufacturers under the Carl Zeiss roof, and not only Zeiss Ikon.

You have somehow preempted my next question, namely when you became aware that this project would mean a much larger – possibly an even dramatically larger – task than originally envisaged – both with regard to the necessary research and its implementing. What did this "ripening" look like? Or did you feel right away that it would be so voluminous?

Well, I tend to believe that it was rather a gradual maturation. The decisive detail for including all those other camera manufacturers was that I knew that Voigtländer had been taken over. Not even the camera retail industry was aware of this, and I also learned it at a rather late point in time.

Let us get back for a moment to that "gradual maturation." If you can time-slice this so precisely – was there at all a point in time when you faced yourself with a "go" or "no go" decision?

To give up has never been an option. Here I would like to emphasize that I made this book as much for myself as the seventy other articles that I have written for various camera collectors' magazines, but that I also want to share with other collectors. It is and has been my quest for a condensed description of a given subject – simply because at some point in time it becomes a pain in the neck to have to glance through all the numerous

records and documents in order to find what you are looking for, let alone the knowledge where there are no records because the brain is your archive – everything needs to be written down. This was not linked to over-ambition but simply for the need to strive for accuracy and completion.

What was the greatest challenge in the course of the writing – was it rather the research or the transfer of results into a "readable" oeuvre?

Well, the implementation was just a lot of work. Let me give you an example of the necessary research. Zeiss published their brochures, catalogues and leaflets in rather short time sequences, and for some camera models there weren't even order numbers. And so there is, for example, a version of the Bi-Tengor from 1926/1927 with a Hypar lens – the camera is, by the way, in my collection – that was listed in only one catalogue edition, and disappeared already in the next edition just a few months later. So if you do not own this specific edition you could not even guess that this version existed, and hence no camera book would ever include it.

Have there been moments when you were desperate and considered ending the project? Which were those moments?

No doubt there were moments like that, but not because of desperation or something similar, but rather because I was sometimes simply not in the mood for it

or had other priorities. This may explain why it took almost thirty years to complete.

If you look at it the other way round – have there been moments of joy and relief?

Of course! Certainly when the book was finally finished, but also when I managed to get hold of a rare brochure or leaflet – these were moments I particularly relished. And it made me proud that, just three days after publication, Professor Gerd Graßhoff from the Berlin Humboldt University announced that the book will be the subject of a research project.

Would you, after all the past experience, start again such a project?

To be honest – rather not.

Is there anything else that you would like to tell our readers?

Yes, and that is I am asking for a big favor. A work of this magnitude cannot possibly be without any mistakes. So if you find anything wrong, or if you even find a camera that is not shown in the Carl Zeiss Kamera-Register, let me know, please – my address is in the book.

Bernd, thank you very much for this interview.

* * *

© Manfred Herrmann, Frankfurt 2013 □

The Carl Zeiss Kamera-Register 1902 – 2012 by Bernd K. Otto

is available from the publisher,

Verlag Rudolf Hillebrand

Kiefernweg 21

41470 Neuss, Germany.

(www.photodeal.de; hillebrand@photodeal.de)

Price: €149 post free in Germany.

Shipping €10 elsewhere in EU; €30 rest of Europe; Overseas €40

The Contarex Book – a review

Larry Gubas, Las Vegas, Nevada

An exhaustive compilation of data on all the camera and lens variations that were offered.

A very ambitious undertaking that comprises the Contarex camera, its lenses and accessories, this book appears in Italian with a parallel English translation on each two-column page. It is lavishly illustrated and has exceptional illustrations of lens diagrams and technical information. Most of the information about the camera is written by Pierpaolo Ghisetti while the lens material is from Marco Cavina.

Although the text was originally written in Italian, a parallel English translation appears in columns adjacent to the Italian.

The camera section covers the development of SLR cameras from the Exakta and other 1930s examples through the 1950s, and it then moves on to the evolution of the features of the various Contarex models. It addresses the perspective of Zeiss Ikon and compares it to the East German and Japanese SLR manufacturers and addresses the evolution of the Japanese SLR manufacturing process when the West German process concentrated on leaf-shutter devices almost exclusively. The material is well researched and developed with strong data with regard to production and serial numbers.

The lens section discusses both the actual production lenses and a great number of

prototypes that have come to light. The lens information and history are well developed, lens by lens, and shows how the use of totally new glasses and materials made these lenses among the very best that were ever made.

There was a continuous evolution of the family of lenses from 1958 to the demise of Zeiss Ikon in 1972 when design development continued with the intention

of offering these splendid lenses to another camera manufacturer and to create designs that could be adapted for Rollei and Hasselblad. The information is the most detailed that I have seen since I discovered "A History of the Photographic Lens" by Rudolf Kingslake.

The language here is more technical and more easily translated, and it has technical data beyond anything else that

I have seen. It is a wonderful exposition of the science and history of this period's design work and personalities. The data are impeccable and impressive, covering the painful design pledge to make this family of lenses reflective of the same color transmittal to film and hence to the print.

The material and structure of the lenses were a totally Carl Zeiss scientific project that permitted no deviation to the process for the convenience of manufacturing simplification. The names of the contributing designers are listed here as are references to many of their patents.

While this is not a book for someone only interested in the pictures within, because the text is quite comprehensive, nevertheless the illustrations far outshine any other work on the subject that I have been able to find. □





Two versions of the Zeiss Olympia-Sonnar 250 mm f/4, as pictured in *The Contarex Book*. On the left is the first version, with preset diaphragm. Below we show the later version, which has a fast-focus device operated by the knob on the photographer's right-hand side. Detailed data about these two lenses appears as a single text running through the two pages opposite to the illustrations.

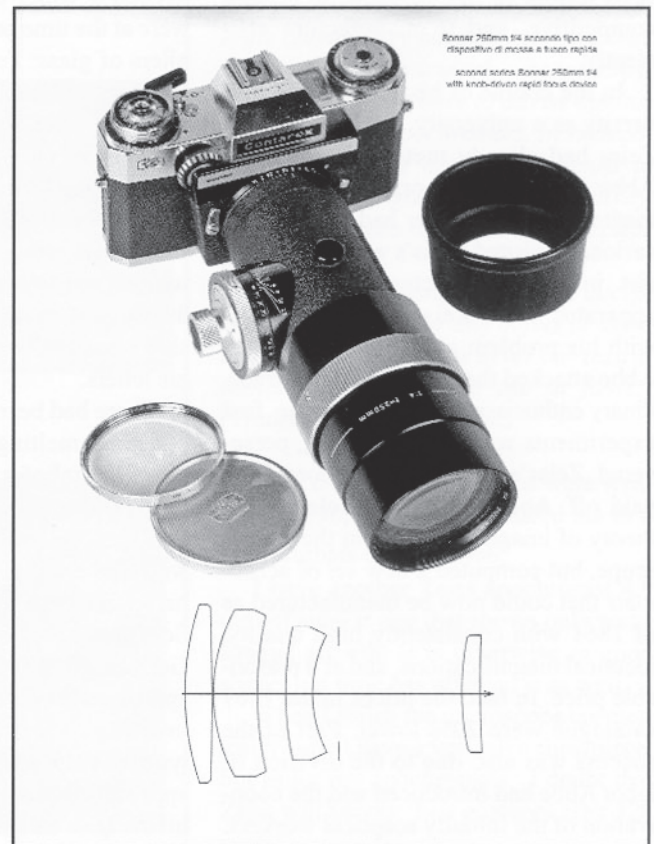

The Contarex Book, by Pierpaolo Ghisetti and Marco Cavina, is published by "New Old Camera" of via Rovello 5 and via Dante 12, Milan, Italy, in a limited edition of 1100 copies. 217 pages. The listed price is €80.00.

info@newoldcamera.it

www.newoldcamera.com

Three early Zeiss Achromats

Fritz Schulze, Vineland, Ontario, Canada

An 1890 catalogue supplement expressed doubt about the durability of some microscope lenses.

His own efforts to compute microscopical systems having failed, Carl Zeiss in the early 1850s engaged Dr F.W. Barfuss, professor of mathematics at the Jena University, to try and find a theoretical solution to his problem. After much time, many calculations, and considerable expense, Barfuss had to admit failure. But Zeiss was not discouraged. He was certain that not only must it be possible to eliminate the costly and time consuming trial-and-error method of making objectives, but that it also was essential to put optics on a scientific basis in order to succeed further in the business, to remain competitive, and to manufacture efficiently.

In the course of his work at the university as a university *mechanicus* Carl Zeiss had already met Professor Ernst Abbe, a poorly paid private lecturer of mathematics. The latter had in effect occasionally visited Zeiss's workshop to assist in the manufacture of scientific apparatus. Now Zeiss approached him with his problem and found open ears. Abbe attacked the problem with extraordinary enthusiasm and, although the first experiments were disappointing, persevered. Zeiss's trust in his new consultant paid off. Abbe not only developed the theory of image formation in the microscope, but computed a new set of achromats that could now be manufactured as of 1861 with consistently high quality, identical magnifications, and at a reasonable price. In fact, the prices in the 1869 catalogue were 20% lower. Part of the success was also due to the division of labor Abbe had introduced and the cooperation of the initially sceptical workers.

Zeiss now realized that Abbe had become indispensable to the company and wanted to secure his continual services. As a by now well renowned scientist Abbe was likely to be offered lucrative

positions. Therefore, in 1875 Zeiss offered Abbe a partnership in the company with 30% of the profits. In loyalty to Zeiss whom he very much respected Abbe refused a tempting offer to go to Berlin and accepted Zeiss's offer instead. He now dedicated himself almost entirely to his work at the Zeiss factory.

Abbe had by then already developed homogenous oil immersion but found himself limited in his computations by the scarcity of suitable optical glass. In his efforts to eliminate the residual secondary spectrum of the achromats he needed a wider choice of glass. There were at the time practically only two suppliers of glass: Feil in Paris and Chance Brothers in Birmingham. Supplies were irregular, often long time in coming and, particularly the French, having no competition in Germany, kept the choicest pieces for themselves. There was only the traditional crown and flint glass, made without consideration for the optical industry just as if it were "intended for ship's ballast," as Abbe wrote in one of his letters.

There had been in the past attempts to put glass melting on a scientific basis. Josef Fraunhofer in Munich and Pierre Louis Guinand of Switzerland, as well as William Vernon Harcourt in England were the early pioneers. But their work has either been lost, forgotten, or failed. So it was just the right time for a young German glass maker, Dr Otto Schott, to appear on the scene. He had been experimenting systematically melting different types of glass and, having heard of Abbe, approached him in 1879, asking to have his samples examined. Abbe realized immediately that this might be the beginning of the solution of his glass problem. From this encounter developed a close cooperation which in 1882 culminated in the establishment of the Jena Glasstech-

nical Laboratory, financed initially by Zeiss, Abbe and Schott. Already by 1883 over 700 experimental melts had been made, but with much higher expenses than anticipated, putting the venture at risk. Germany, or more precisely Prussia, was always unhappy depending on imported glass. For the promise to develop a stable thermometer glass, suitable for calibration, Berlin supported the new venture with a substantial grant, thus ensuring its survival. In a short while not only the requested thermometer glass but also a heat resistant glass, Duran, or Jena glass as it became known, was developed. The principal advantage of the glass produced by Schott was its consistency and reliability. A catalogue listed the available glass types with all critical optical characteristics.

Abbe had now a source of the optical glass he needed for his further computations of better corrected optical systems. His new apochromats eliminated the residual secondary spectrum of the achromats and yielded a sharp, clear image without any color fringes, far superior to anything so far achieved. These objectives contained, besides the new glass types, also natural crystals such as fluorite.

Now I come to the actual reason of writing this article.

Some time ago I acquired on eBay a Carl Zeiss stand IIa in a rather poor condition, which did not faze me as it is my hobby to recondition old instruments. It tells me, though, that the instrument must have been stored a long time in very inclement conditions. But it listed three apochromats! A rare find. Judging from its serial number the stand dates from around 1892, therefore, the apochromats must be some of the earliest ones. And

they are indeed, for when I tried to look at a specimen they turned out to be totally useless. Actually the inner topmost lenses were so corroded that they appeared almost crystallized. What a disappointment!

I am reminded of a few paragraphs in a Supplement to the (Zeiss) Catalogue No. 28 "Mikroskope und mikroskopische Hilfsapparate" 1890: (Please note that it is partly written in the first person!)

"Haltbarkeit der Apochromate"
(Durability of Apochromats)

Furthermore I would like to use this opportunity to reduce to a reasonable level the rumours circulating in the public regarding the durability of the apochromats.

As is only natural with a new product, we were not successful in all aspects of our first tests. Some of our first apochromats (but by far the fewest!) experienced some internal glass deterioration without external visible damage. The glass became turbid, the image fuzzy, the objective unuseable. It turned out that some types of glass used in these systems – de-

spite several tests in the laboratory – did not stand up in practical use.

Surely we cannot be blamed for such individual misfortunes in a totally new field. We endeavoured to compensate any customer by exchanging without hesitation any optical system that showed such deterioration for a new one with more durable glass. Once it was established that certain types of glass showed unusual lack of durability we redesigned all apochromats and replaced those glasses with ones of notably better durability.

How long these new glasses will remain clear cannot be said with certainty a priori. We can only assure you that according to their chemical composition we can expect a higher resistance against climatic, thermal, and chemical influences and can state that till now, that is, within the past 5 years [see note below], no further complaints of defects under normal use have reached us.

Of course, in the long run even these new glasses may deteriorate. In our moderate climate they have proven excellent. In the tropics, particularly where there is high humidity, we have to advise against the use of these apochromats. In such climates where the atmosphere tends to have unusual highly aggressive activity, possibly no glass at all can remain clear for ever.

It goes without saying that we accept full responsibility for any defect or damage of these lenses – as of all our instruments – so far as we are at fault."
(Translation by the author.)

Note that these paragraphs were written in 1890, but Abbe produced his first apochromats only in 1886.

I have another Zeiss apochromat 4.0 mm of similar age that shows only some fungus growth. It is otherwise in good shape, but time has affected it as well.

When I finish the microscope cosmetically I shall have a very nice showpiece, but as for my apochromats, I doubt that Zeiss will honour their guaranty after 120 years!

We often think of glass as something immutable, but under the influence of acids, alkalis, moisture, heat and so on it can change; just watch some glasses turn milky in the dishwasher! □

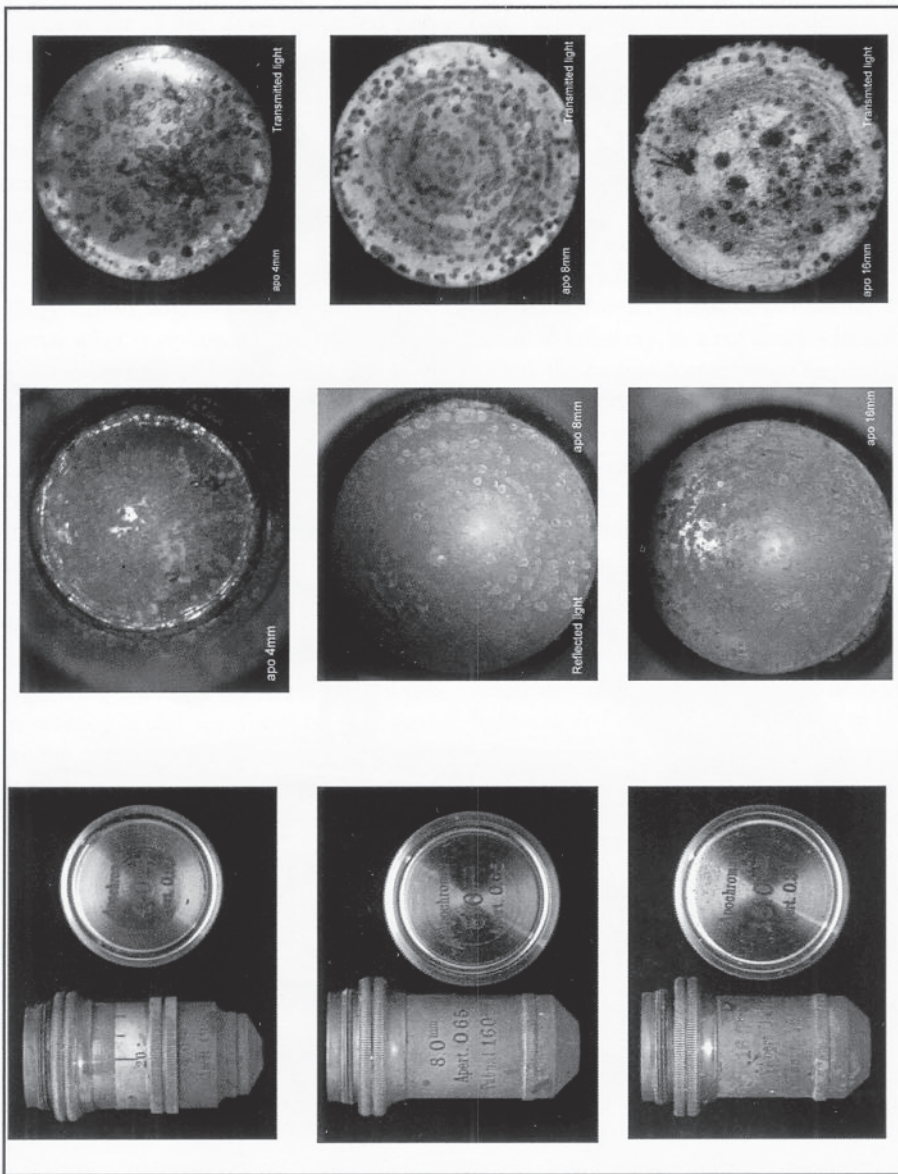

The three apochromats discussed in this article appear in the bottom row, left to right: 4 mm, 8 mm, and 15 mm. The middle row shows the same three apochromats viewed by reflected light, and in the top row they are seen by transmitted light. After about 120 years they have all become useless.

The Optovar. . .

. . . a Zeiss microscope accessory that permits rapid changes of magnification

Fritz Schulze, Vineland, Ontario, Canada

The Optovar magnification changer was originally introduced by Carl Zeiss Oberkochen/West Germany in 1954 as an accessory to the Stand W. This microscope was the first post-war microscope designed by Walter Kinder at Oberkochen and incorporated a number of major innovations. As such it deserves a separate essay. What I would like to discuss here is the Optovar magnification changer. Still today it is a much valued accessory to any Zeiss microscope of the Standard series and has, in principle, been incorporated in many newer stands since.

The Optovar is an intermediate tube with a magnification changer, it also features an Amici-Bertrand lens (which acts as an auxiliary microscope) and an analyser.

The multi-step magnification changer permits factors of $1\times$, $1.6\times$, and $2.5\times$. Later versions have the factors $1\times$, $1.25\times$, $1.6\times$, and $2\times$. The Optovar as integrated in the larger Standard Universal, Photomicroscope, and Ultraphot offers the factors $1.25\times$, $1.6\times$, and $2\times$. This allows the microscopist to bridge over the magnification gaps between objectives in small steps, and this avoiding the need to change the eyepieces frequently. The optical systems to achieve this are arranged on a rotatable disc and can be switched in as desired.

For instance, with a standard set of objectives $2.5\times$, $10\times$, $40\times$, and $100\times$ and an

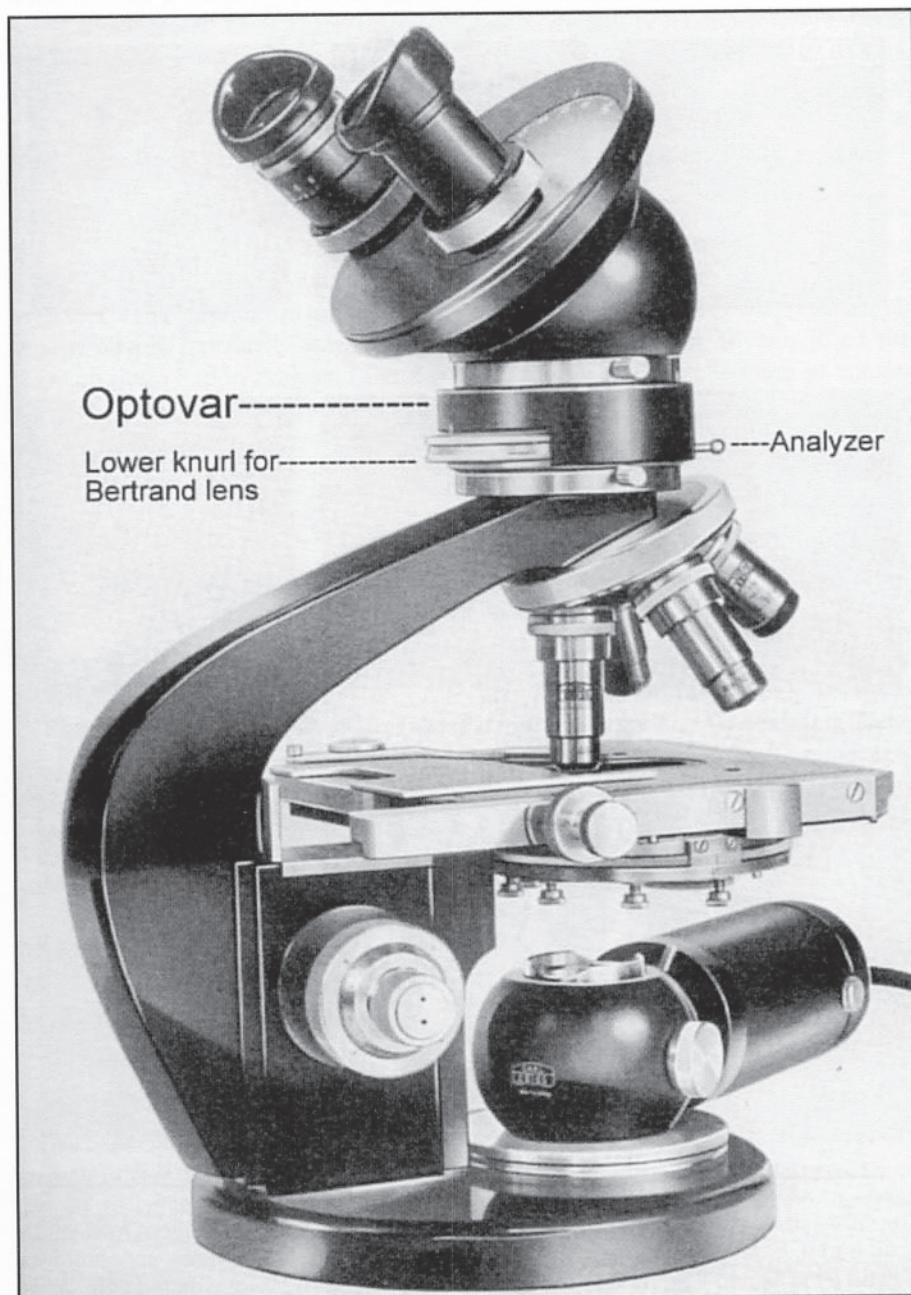

→
The Carl Zeiss Stand W with the Optovar attached

eyepiece 8× the following magnifications can be obtained:

20 – (25) – 32 – (40) – 50 – (63) – 80 – (100) – 125 – (160) – 200 – (250) – 320 – (400) – 500 – (630) – 800 – (1000) – 1250 – (1600) and 2000×,

which is the DIN series in steps of 1.6×, with additional steps of 1.25× in parentheses. The numbers are rounded off.

When Leitz started to offer their Large-field Orthoplan with considerably increased field numbers, requiring special tubes with larger diameter and corresponding eyepieces in the 1970s, Zeiss responded with the Wide-field Optovar: the factors were reduced by 1.25× and the wide-angle eyepiece magnification correspondingly increased by 1.25×. This resulted in the same magnification and the same large field as the Leitz system but without having to use a special tube and eyepieces!

The Amici-Bertrand lens, as it is officially called, together with the eyepiece forms what is commonly also known as a phase-contrast centering telescope or an auxiliary microscope, and is well known to users of polarizing microscopes. It serves to view the rear focal plane (exit pupil) of the objectives. In other words: it shifts the filament plane into the image plane. In the Optovar, the A-B lens is set in a helical mount that can be controlled by a separate wheel so one can focus up and down to reach the rear focal plane of objectives from 16× to 100×. With it the microscopist can see, focus on, and center the phase rings of the phase-contrast system, while also checking the setting of the condenser aperture diaphragm and

the correct centering of the filament of the light source.

It is a most useful tool to inspect the optical system for any misalignment, vignetting, dirt in the objective or air bubbles in the oil immersion. With it one can also detect any cracked or damaged lenses, fungus or delamination in the objective. The main convenience is the elimination of having to remove the eyepiece and to insert the auxiliary telescope each time one wants to check the objective's aperture or the phase rings.

Lastly, the Optovar includes a swing-out analyser. The biologist needs only to place a polarizer under the condenser to render the instrument into a simple polarizing microscope to examine crystals or other birefringent material.

How was this all achieved?

We all know that the microscopes of the period have a definite tube length of 160 mm. Interposing an accessory of 30mm thickness would extend this number to 190mm, affecting, to a not inconsiderable extent, the optical correction of the image and the parfocalization. In order to avoid this the Optovar has a negative Telan-lens at the bottom, which creates an “infinite” light path. The different magnifications are achieved by small Galilean telescopes, that is, a positive objective lens and a negative eyepiece lens. They are very short and as such extremely well suited to be installed in a small device such as the Optovar. The light enters from infinity and exits to infinity. A positive Telan-lens of equal power at the upper side of the Optovar recreates again the original condition so

that the image is focused on the proper plane in the eyepiece.

Personally I think the Optovar is one of the finest microscope accessories Zeiss has ever invented. I have one on my Gfl and one integrated in my Photomicroscope and I use them all the time. Optovars appear rarely on eBay but would be worth the price. □.

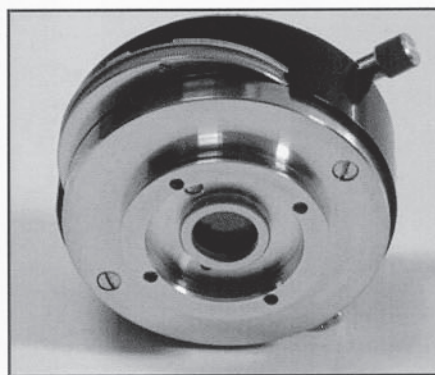
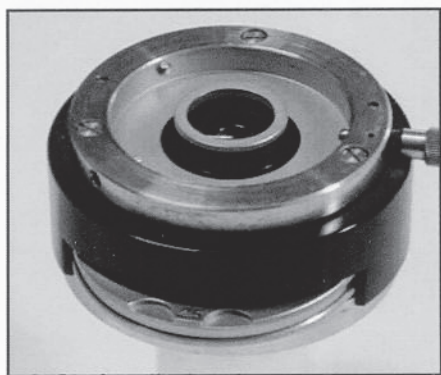

Carl Zeiss Optovar Magnification Changer Intermediate Tube, above (left) and from below (right).

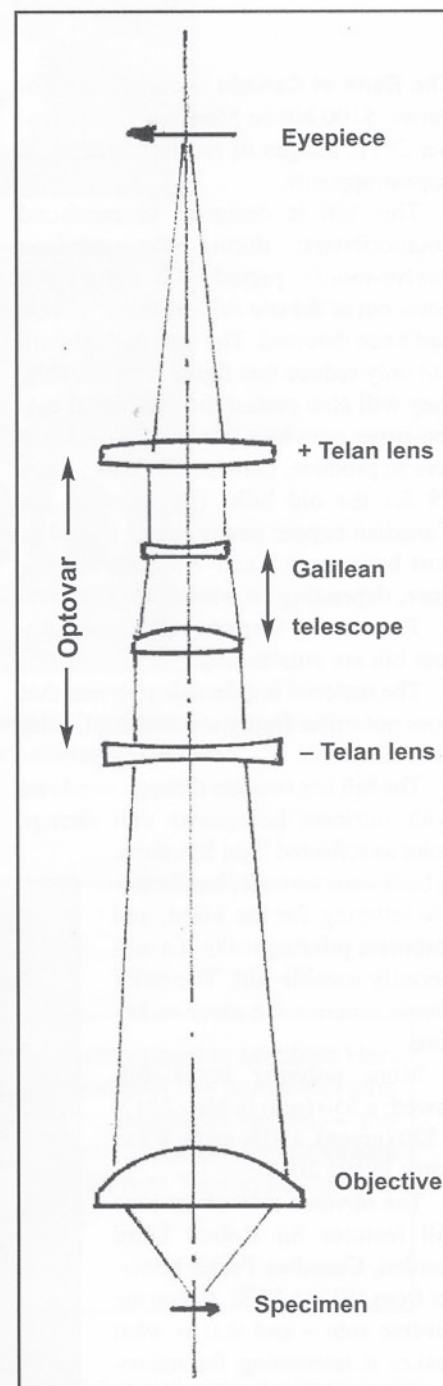

Schematic of the optical principle.

The Canadian \$100 banknote

Fritz Schulze, Vineland, Ontario, Canada

The design features a microscope that looks a lot like the Zeiss Axioplan – but with significant differences

The Bank of Canada unveiled its innovative \$100 bill on Monday, 14 November 2011. Images of the front and back appear opposite.

This bill is designed to confound counterfeiters: during the previous twelve-month period 470 counterfeit notes out of the one million in circulation had been detected. The new bills should not only reduce this figure considerably, they will also outlast the traditional cotton-paper ones by a factor of 2.5 and cost less to produce, perhaps 10 cents versus 19 for the old bills. (By contrast the Canadian copper penny (cent) is said to cost between 0.8 and 1.6 cents to produce, depending on whom you ask!).

The security features of the new polymer bill are outstanding:

The material is a durable polymer that does not suffer from moisture, heat, cold, or folding.

The bill has two see-through windows with intricate holograms that change color as reflected light hits them. A bank counter code, braille tactile lettering for the blind, and elaborate printing make it a universally useable bill. The color theme remains the same as before.

More polymer notes followed: a \$50 (red) in May 2012, a \$20 (green), a \$10, and a \$5 to come in late 2013.

The obverse side of the new bill features Sir Robert Laird Borden, Canadian Prime Minister from 1911 to 1920, and on the reverse side – and that is what makes it interesting for microscopists and justifies this article being published here – it features a scientist seated at a modern mi-

croscope, plus a bottle of insulin, a DNA chain and an ECG graph, all of these to represent Canadian achievements in medicine: the invention of Insulin, the unraveling of the DNA, and Canadian contributions to heart health.

The microscope had me puzzled: on the one hand it looked very familiar, but certain features did not fit. I checked similar stands from Leica, Nikon, and Olympus, neither had a stand that came close, as far as I could find out. So I came back again to the Carl Zeiss 1995 Axioplan. You may compare the two illustrations, below. It seems to me that the illustrating artist made some minor changes in order not to be accused of promoting a certain make. Therefore the microscopic sleuth has to carefully compare certain betraying details in order to find out on what make and stand the artist based his design. One typical design feature of the Zeiss Axioplan is the T-shaped footprint and the slanted back, the “pyramid.”

These features are very obvious in the bill’s illustration. The tubehead is stepped while in the original it is slanted, and the filter wheels are shown behind the focusing knobs instead of in front. You can really play “Find the difference...”

That reminds me of the 1997 issue of a 200 Deutschmark banknote, which showed on the obverse Paul Ehrlich, a famous German serologist (1854 – 1915), and on the reverse his microscope, a Zeiss Stand IV #3078 (That number is, of course, not apparent on the bill, but I have a note from another publication, that this was the microscope Ehrlich used).

Microscopes have appeared on other banknotes (Brazil) and, like microscopes on stamps, make fine subjects for study for microscopists interested in such trivia.

* * *

Note: The reproductions of the new bill are used with the permission of the Bank of Canada. □

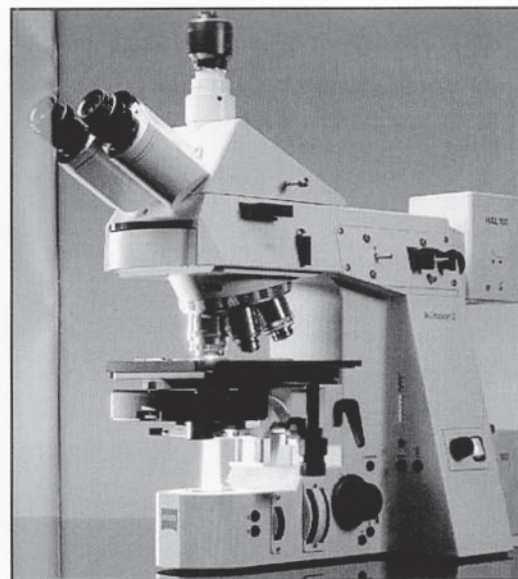
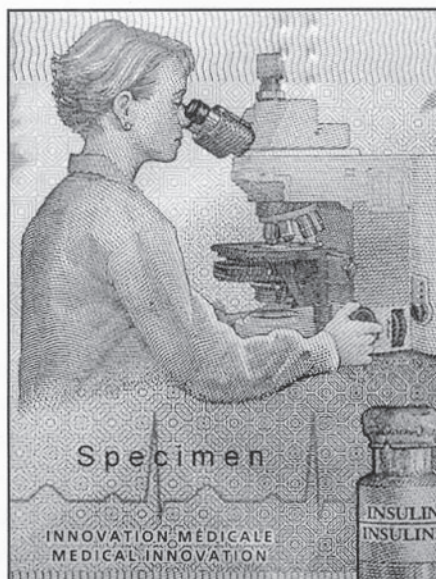



The Canadian \$100 banknote. Note on the back of the note (lower picture) the image of a microscope in use. It looks similar to the Zeiss Axioplan, although certain details have been changed. (Images supplied by Fritz Schulze.)

On the back cover: The green Werra IV described in Manfred Herermann's article on page 6. Here it is shown with the combined lens hood and lens cap, and also the two interchangeable lenses — the f/2.8 35 mm Flektogon and the f/4 100 mm Cardinar. These lenses require more space than the normal f/2.8 50 mm Tessar, so the lens hood has a more bulbous shape than before.

Photo by Stefan Köser.



Achtung!

Beim Aufschrauben der Gehäusekappe
de als Schutzkappe das die um Objektiv
bleibt. Bei unvorsichtiger Benutzung
ausgenutzt nicht zulässige Filter
auf Grund des Schutzkappe nicht
schreiben, nicht mit Schutzhülse
aktiv und Schutzkappe

WERRA